

# *Camco*

**THE ARISTOCRAT  
OF THE  
DRUM WORLD**



# Camco "THE ARISTOCRAT" OF THE DRUM WORLD

DRUMS THAT ARE CRAFTED TO THE QUALITY OF FINE MUSICAL INSTRUMENTS

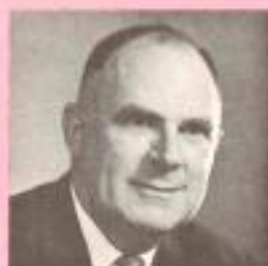

JOHN ROCHON  
President



CLAIRE MAYER  
Secretary



ALFRED KNABLE  
Shop Supt.



CHUCK MOLINARI  
Advisor

## INDEX

Bass Drums	11	Drum Eye	27	Slings, Bell Lyra	31
Bass Drum Anchors	19	Drum Key	27	Slings, Drum	27
Bass Drum Mufflers	30	Drum Major Whistles	27	Snare Drums	7, 8, 9
Bass Drum Racks	27	Drum Outfits	3, 4, 5, 6	Snare	30
Cases, Fibre	32	Drum Stands	16	Snare Drum Muffler	30
Castanets	29	Gongs and Stands	24	Snare Strainers	33
Ching Ring	25	Greeko Cymbals	24	Song Whistles	29
Claves	28	Guero	28	Spurs	19
Covers	32	Heads, Plastic	26	Square Head Rods	34
Cow Bells	28	Hi-Hat Stands	15	Sticks, Base Drum	
Cow Bell Holders	17-30	Imitations	29		22, 23, 27
Cymbals	24	Instruction Books	31	Sticks, Snare Drum	20, 23
Finger Cymbals	24	Key Holders	27	Sticks, Tenor	23
Cymbal Clutches	15	Kits, Drum	9	Sticks, Tympani	22
Cymbal Clutches	15	Latin Accessories	28	Tambourines	29
Cymbal Floor Stands	16	Leg Rests	27	Thrones	16
Cymbal Holders, Band	25	Mallets	22, 23, 31	Tom-Toms	10
Cymbal Holders,		Maracas	28	Tom-Tom Holders	18
Bass Drum	17	Parade Drums	9, 12, 13	Tom-Tom Legs	10
Cymbal Holders, Brush	17	Pedals	14	Tone Controls	30
Cymbal Holders, Shell	17	Pedal Beaters	19	Triangles	30
Cymbal Holders, Wood	25	Practice Pads	21, 26	Triangle Holders	30
Cymbal Pads	25	Practice Pad Stands	21	Whistles	27, 29
Cymbal Straps	25	Practice Pad Sets	26	Wire Brushes	21
Cymbal Pouches	32	Replacement Parts	33, 34	Wood Blocks	28
Cymbal Sizzlers	25	Slap Sticks	29	Wood Block Holders	30
Cymbal Tilters	15	Sleigh Bells	29	Wood Rattle	29
				Wood Whistles	29

## TERMS

### CAMCO PRODUCTS ARE SOLD THROUGH DEALERS IN OPEN TERRITORIES ONLY

All previous quotations cancelled. All prices are list, subject to change without notice and to the usual terms. F.O.B. shipping point. New accounts please submit three trade references and bank.

Substitutions permissible. Colors matched on non-cancellable, non-returnable basis. All metal parts chrome plated. Heads and Cymbals not guaranteed.

Plastic heads standard on all drums unless otherwise specified. Calf Skin Heads priced extra.

Claims for losses, damages or pilferage must be made to the Transportation Company. Our responsibility ceases upon delivery to the Transportation Company. Shipments should be opened and examined immediately for loss or damage, either **VISIBLE** or **CONCEALED**.

Check all contents and save all cartons and packing material. Call your local agent at once for an inspection. Obtain a signed inspection report from him and file claim for loss or damage.



EDDIE GRAHAM  
Clinician



SHELDON ELIAS  
Clinician

**Camco DRUM COMPANY**

9221 SOUTH KILPATRICK AVENUE  
OAKLAWN ILL. 60453 • Area Code (312) PHONE 423-2900

# Camco

## "BIG BAND" OUTFIT

- Double Flange Counter Hoops

- 6-Ply Electronically Bonded Shells

- All Metal Parts AAA Chrome Plated

1	450	Aristocrat 5 x 14 Snare Drum	\$ 90.00
2	1120	Aristocrat 14 x 20 Bass Drums	270.00
2	1412	Aristocrat 8 x 12 Tom-Tom	150.00
1	1414	Aristocrat 14 x 14 Tom-Tom	90.00
2 pr	1480	Arch Disappearing Spurs	17.00
1	19	Double Swivel Tom-Tom Holder on a stand	35.00
1 set	4410	Tom-Tom Legs	10.00
2	5000	Deluxe Foot Pedals	55.00
1	900	Direct Pull Hi-Hat Stand—Flush Legs	39.50
2	700	Cymbal Stands	28.00
1	850	Buck Rogers Drum Stand—Flush Legs	17.50
1 pr	1070	Wire Brushes, Rubber Covered Handles, Loop End	1.75
2	1430	Felt Muffler Strips	2.00
1 pr		Drum Sticks	1.60
		Total Value in choice of Pearl Finishes	807.35
		Special Price:	
		Pearl Finishes	767.00
		Lacquer or Stain Finishes	694.00
		Moire Finishes	807.00

Cymbals Not Included

DRUMS SHOWN IN 3-D MOIRE



### TRIPLE TOM-TOM OUTFIT

AS SHOWN  
ON COVER

#### DRUM SIZES

5 x 14	10 x 14
8 x 12	16 x 16
9 x 13	14 x 22

#### Special Prices:

Pearl	\$720.00
Lacquer or Stain	656.00
Moire Finishes	757.00

# Camco

## "DOUBLE TOM-TOM" OUTFIT

1	450	Aristocrat 5 x 14 Snare Drum	\$ 90.00
1	1122	Aristocrat 14 x 22 Bass Drum	140.00
2	1412	Aristocrat 8 x 12 Tom-Toms	150.00
1	1416	Aristocrat 16 x 16 Tom-Tom	100.00
1 pr	1480	Arch Disappearing Spurs	8.50
1	5000	Deluxe Foot Pedal	27.50
1	650	Buck Rogers Drum Stand—Tripod Legs	17.50
1	500	Direct Pull Hi-Hat Stand—Tripod Legs	39.50
1	18	Double Swivel Tom-Tom Holder	27.50
2	700	Cymbal Stands	28.00
1 set	4410	Tom-Tom Legs	10.00
1 pr	1070	Wire Brushes, Rubber Covered Handles, Loop End	1.75
1	1430	Felt Muffler Strip	1.00
1 pr		Drum Sticks	1.60
		Total Value in choice of Pearl Finishes	\$642.85
		Special Price:	
		Pearl Finishes	\$611.00
		Lacquer or Stain Finishes	557.00
		Moire Finishes	642.00

Cymbals  
Not  
Included

with "ARISTOCRAT" Drums

- Double Flange Counter Hoops
- 6-Ply Electronically Bonded Shells
- All Metal Parts AAA Chrome Plated

Here is the "Big Apple" of all drum outfits . . . designed for the drummer who is seeking the complete range of sounds—with true drum character in every beat—and with a full measure of modern styling and mechanical perfection. This set is for both large and small bands. It is right for the classics or for jazz. There is nothing finer to be had and nothing that will give greater playing satisfaction and eye appeal than the advanced Double Tom-Tom Outfit.

DRUMS SHOWN IN BLUE MOIRE



1	450	Aristocrat 5 x 14 Snare Drum	\$ 90.00
1	1120	Aristocrat 14 x 20 Bass Drum	135.00
1	1412	Aristocrat 8 x 12 Tom-Tom	75.00
1	1414	Aristocrat 14 x 14 Tom-Tom	90.00
1 pr	1480	Arch Disappearing Spurs	8.50
1	15	Single Swivel Tom-Tom Holder	20.00
1 set	4410	Tom-Tom Legs	10.00
1	1450	Shell Mount Cymbal Holder	8.50
1	5000	Deluxe Foot Pedal	27.50
1	500	Direct Pull Hi-Hat Stand—Tripod Legs	39.50
1	650	Buck Rogers Drum Stand—Tripod Legs	17.50
1	1103	Cow Bell	3.00
1	1422	Cow Bell Holder	3.00
1 pr	1070	Wire Brushes, Rubber Covered Handles, Loop End	1.75
1	1430	Felt Muffler Strip	1.00
1 pr		Drum Sticks	1.60
		Total Value in choice of Pearl Finishes	\$531.85
		Special Price:	
		Pearl Finishes	505.00
		Lacquer or Stain Finishes	456.00
		Moire Finishes	530.00

# Camco

## ASTRO OUTFIT



- Double Flange Counter Hoops

- 6-Ply Electronically Bonded Shells

- All Metal Parts  
AAA Chrome Plated

DRUMS SHOWN IN BURGUNDY SPARKLE

# Camco

## SWINGER OUTFIT

1	450	Aristocrat 5 x 14 Snare Drum	\$90.00
1	1120	Aristocrat 14 x 20 Bass Drum	135.00
1	1412	Aristocrat 8 x 12 Tom-Tom	75.00
1 pr	1480	Arch Disappearing Spurs	8.50
1	1435C	Chrome Consolette Tom-Tom Holder	13.50
1	1450	Shell Mount Cymbal Holder	8.50
1	5000	Deluxe Foot Pedal	27.50
1	800	Hi-Hat Stand—Flush Base	24.00
1	600	Drum Stand—Flush Base	15.00
1 pr	1070	Wire Brushes, Rubber Covered Handles, Loop End	1.75
1	1430	Felt Muffler Strip	1.00
1 pr		Drum Sticks	1.60
		Total Value in choice of Pearl Finishes	401.35
		<b>Special Price:</b>	
Cymbals		Pearl Finishes	381.00
Not		Lacquer or Stain Finishes	348.00
Included		Moire Finishes	399.00

DRUMS SHOWN IN WALNUT STAIN

# Camco

## TUXEDO OUTFIT

1	701	Tuxedo 5 x 15 Snare Drum	\$ 79.50
1	2330	Tuxedo 14 x 20 Bass Drum	125.00
1	3012	Tuxedo 8 x 12 Tom-Tom	65.00
1 pr	1480	Arch Disappearing Spurs	8.50
1	1450	Shell Mount Cymbal Holder	8.50
1	1435C	Chrome Consolette Tom-Tom Holder	13.50
1	600	Drum Stand—Flush Base	15.00
1	800	Hi-Hat Stand—Flush Base	24.00
1	5000	Deluxe Foot Pedal	27.50
1 pr	1070	Wire Brushes, Rubber Covered Handles, Loop End	1.75
1	1430	Felt Muffler Strip	1.00
1 pr		Drum Sticks	1.60
		Total Value choice of Pearl Finishes	370.85
		<b>Special Price:</b>	
Cymbals		Pearl Finishes	352.00
Not		Lacquer or Stain Finishes	318.00
Included		Moire Finishes	370.00

DRUMS SHOWN IN CHAMPAGNE SPARKLE

# Camco NO. 99 SUPER



## NEW PARALLEL STRAINER

\$119.00

5x14  
in Metal or  
Choice of Pearls



### FEATURES . . .

- Snare Contacts Head Even
- Choke Free Sound
- 16 Strand Snare
- Polished Chrome Shell
- Triple Flange Hoops
- Internal Tone Control
- Camco Key Holder and Key

## TUXEDO METAL DRUM

- TRIPLE FLANGE HOOPS
- 20 STRAND SNARE
- CHROME SHELL
- TONE CONTROL
- KEY HOLDER AND KEY
- 8 LUGS



No. 701-M 5x14 Snare Drum ..... \$98.00

99-M Super—Chrome Shell ..... \$119.00

99-P Super—Choice of Pearl ..... \$119.00



JOEY CASS  
New York



JOE DUKES  
Jack McDuff



RICK FRIGO  
Chicago



NORM JEFFRIES  
Hollywood Palace



STEVE RILLERA  
Santa Ana



SID BULKINS  
Las Vegas



MEL BROWN  
Temptations



EDDIE KNIGHT  
South Bend



HAP GORMLEY  
New York



NORBY KING  
Chicago



KALIL MADI  
Big Tiny Little



TONY CASELLI  
Chicago



PAUL HUMPHREY  
Hollywood



ALAN LASCHIVER  
California



MARSHALL THOMPSON  
Chicago



TONY DEE  
"NTH" Hollywood



DENNIS WILSON  
Beach Boys



JIMMY SMITH  
Erroll Garner



JERRY PUTNAM  
Puerto Rico



MORGAN GRANT  
Honolulu



FRANK KIM  
Honolulu



ROSS HAYASHIDA  
International Set



EDDIE SWAN  
Los Angeles



BART TUNICK  
Seattle



## THE "ARISTOCRAT"

A great number of top ranking professionals declare the 5 x 14 size drum to be the best for those who do all-around work with different groups. The "ARISTOCRAT" 5 x 14 has both delicacy and volume and will withstand hard usage on the road. It is a "tailor-made" instrument of mechanical efficiency and modern styling . . . A wonderful easy-playing drum, with sounds that will please the perfectionist.

### ORCHESTRA

450-P 5x14 Choice of Pearls .....	\$90.00
450-L 5x14 Choice of Lacquers .....	82.00

### CONCERT ARISTOCRAT

452-P 6½x14 Choice of Pearls .....	\$92.00
452-L 6½x14 Choice of Lacquers .....	84.00

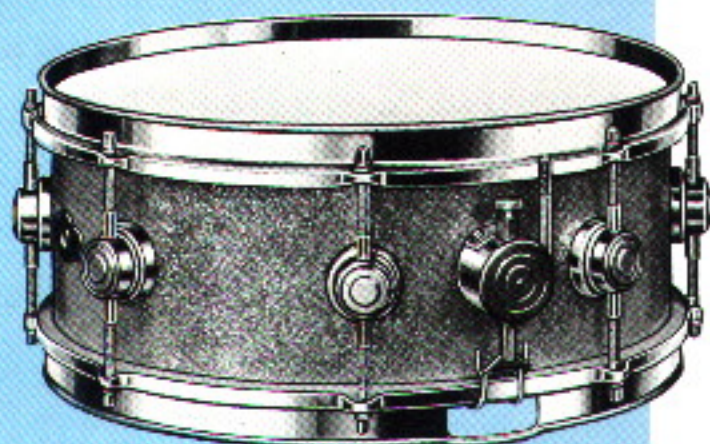

#### Tone Control

Choice of Calf or Plastic Heads  
Photo Shows 5 x 14 in Sparkling Gold



#### Tone Control

All Metal Parts on All Drums Are  
AAA Chrome Plated  
Photo Shows 8 x 15 in Mahogany

## THE BAND "ARISTOCRAT"

This is a real "drummer's drum," with colorful, rich and penetrating sounds that make it the very "tops" for large concert bands and orchestras. It is the correct size for producing great volume; yet it is so sensitive that it can be played down to a "whisper." Like all "ARISTOCRATS," it is very carefully made in every part—even to finishing the inside of the shell.

456-P 8x15 Choice of Pearls .....	\$95.00
456-L 8x15 Choice of Lacquers .....	87.00

Gut Snares—\$2.00 Extra

**ALL METAL PARTS  
TRIPLE CHROME  
PLATED**

## STUDIO MODEL

701-EL 5x14 Lacquer or Mahogany..	\$55.00
701-EP In Pearl .....	65.00

8 Lug  
Triple Flange Hoops



## THE 'ORCHESTRA' TUXEDO

5x14 Snare Drum  
Drum Shown in Blue Moire

701-P In Pearls .....\$79.50

701-L In Lacquers ..... 69.50

712-P 6½x14 Choice of Pearls...\$81.50

712-L 6½x14 Choice of Lacquers .. 71.50

Tone Control and Key Holder and Key Included  
8 Streamline Lugs

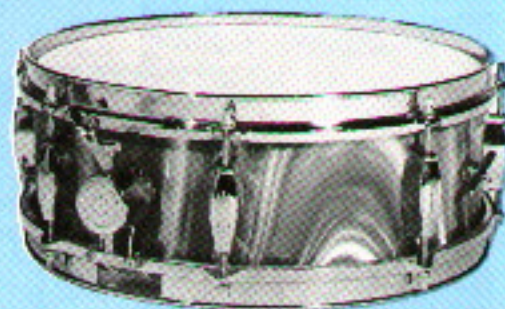

## No. 910-D DELUXE DRUM KIT

701-EP 5x14 Pearl Snare Drum ..\$65.00

Blue Student Case ..... 21.00

1100 Round Practice Pad ..... 3.00

1716-C Chrome Drum Stand ..... 10.50

1 pair 2-B Drum Sticks .. 1.60

**TOTAL VALUE: \$101.10**

**SPECIAL PRICE: 96.00**



## 10" x 14" PARADE DRUM

515-L In Lacquer  
or Mahogany \$65.00

515-P In Pearl \$75.00

Sticks, and Sling  
Choice of Wood or Metal  
hoop, 8 Rod.

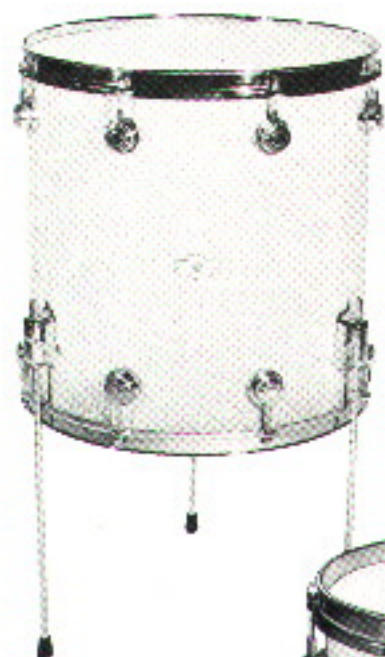

Photo Shows  
16x16 in  
3D Moire  
and 4416  
Tom-Tom Legs



Photo Shows  
9x13 in  
White Pearl



Photo Shows  
14x14 in  
Blue Moire  
and 4412  
Wide Spread Legs

## "ARISTOCRAT" TOM-TOMS

All "ARISTOCRAT" Tom-Toms have our exclusive Double Edge-Double Flange Hoops and "turret" casings with self-aligning rods. All shells are 4-Ply electronically bonded, with reinforcing hoops. Shells are finished on the inside to prevent moisture penetration. Tone Control included.

		Stain or Lacquer	Pearl
1412	8x12	\$ 68.00	\$ 75.00
1413	9x13	72.00	80.00
1410	10x14	74.00	84.00
1415	12x15	75.00	84.00
1414	14x14	75.00	90.00
1416	16x16	85.00	100.00
1418	16x18	108.00	124.00
1420	18x20	124.00	144.00

## CAMCO TOM-TOM LEGS

There are 12 ring notches turned into each of the chrome plated legs. Wing screws seat themselves into the notches. Legs cannot slip.

4410	3 Legs and Brackets.....	\$10.00
4411	1 Leg and Bracket.....	3.35

## "TUXEDO" TOM-TOMS

		Stain or Lacquer	Pearl
3012	8x12	\$ 59.00	\$ 65.00
3013	9x13	62.00	67.50
3014	14x14	68.00	80.00
3016	16x16	72.00	85.00

## CAMCO WIDE SPREAD TOM-TOM LEGS

The fine notches turned into the legs provide ample height adjustment and positively prevent slipping under heavy beating. Note that legs flare outward.

4412	3 Legs and Brackets.....	\$12.00
4413	1 Leg and Bracket.....	4.00

# Camco

## "ARISTOCRAT" BASS DRUMS

Drummers and leaders in both the school and professional fields must have the particular "sound style" that blends in with the musical character of their special organization. Jobbing drummers often have to alter the sounds for different groups. We are, therefore, building our bass drums to withstand the necessary adjustments. They have 6-Ply electronically bonded shells, with reinforcing hoops. The steel double claw hooks are of thicker gauge and have a wider bearing surface than those on most drums. The finishes are top grade, including hand-rubbed lacquers. These are indeed rugged, beautiful drums that can be adjusted to sounds required on any job.

		Stain or Lacquer	Pearl
1118	14x18	\$110.00	\$130.00
1120	14x20	115.00	135.00
1122	14x22	120.00	140.00
1124	14x24*	130.00	153.00

\*14x24 has 10-Lugs

## "TUXEDO" BASS DRUMS

		Stain or Lacquer	Pearl
2328	14x18	\$100.00	\$120.00
2330	14x20	105.00	125.00
2332	14x22	110.00	130.00
2334	14x24	115.00	140.00



*Photo Shows 14x22 in White Pearl*





## Camco "PARADE MASTERS"

- CHROME
- 4-PLY SHELLS
- SNAP IN KEY HOLDER
- DELUXE STRAINER
- INTERNAL TONE CONTROL
- SEPARATE TENSION

### PARADE MASTER SNARE DRUM Complete with Drum Sticks and Slings

		Lacquer	Pearl
458	10x14	\$ 80.00	\$ 93.00
460	12x15	93.50	107.00
462	12x16	95.00	108.00

### PARADE MASTER TENOR DRUMS Complete with Beaters and Slings

		Lacquer	Pearl
464	10x14	\$ 80.00	\$ 93.00
466	12x15	93.50	107.00
468	12x16	95.00	108.00

### PARADE MASTER SCOTCH BASS DRUMS Complete with Slings and Beaters

		Lacquer	Pearl
1145	8x24	\$123.00	\$145.00
1146	10x24	123.00	145.00
1147	8x28	133.00	155.00
1148	10x28	133.00	155.00

Moire Covering Extra



*Long Island Strikers*

*For inlaid hoops on lacquer drums add \$5.00  
Plastic heads furnished unless other specified  
Gut Snarex \$2.00 Extra*

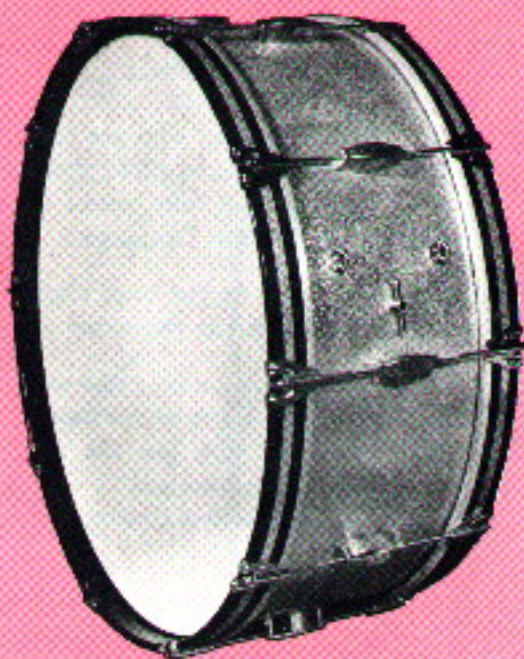

## Camco "PARADE QUEEN"

- CHROME
- 4-PLY SHELLS
- SNAP-IN KEY HOLDER
- STREAMLINE CASINGS
- SEPARATE TENSION
- INTERNAL TONE CONTROL

### SNARE DRUMS

complete with Sticks and Sling

713-L	10x14	Lacquer or Mahogany	\$ 69.00
713-P	10x14	Choice of Pearl	82.50
716-L	12x15	Lacquer or Mahogany	84.00
716-P	12x15	Choice of Pearl	94.00
718-L	12x16	Lacquer or Mahogany	88.50
718-P	12x16	Choice of Pearl	99.00

### TENOR DRUMS

complete with Tenor Sticks and Sling

720-L	10x14	Lacquer or Mahogany	\$ 69.00
720-P	10x14	Choice of Pearl	82.50
722-L	12x15	Lacquer or Mahogany	84.00
722-P	12x15	Choice of Pearl	94.00
724-L	12x16	Lacquer or Mahogany	88.50
724-P	12x16	Choice of Pearl	99.00

### SCOTCH BASS DRUMS

complete with Slings and Beaters

3018-L	8x24	Lacquer or Mahogany	\$118.00
3018-P	8x24	Choice of Pearl	140.00
3020-L	10x24	Lacquer or Mahogany	118.00
3020-P	10x24	Choice of Pearl	140.00
3022-L	8x28	Lacquer or Mahogany	128.00
3022-P	8x28	Choice of Pearl	150.00
3024-L	10x28	Lacquer or Mahogany	128.00
3024-P	10x28	Choice of Pearl	150.00

Moire Covering Extra



*St. Joseph Military Academy  
La Grange, Ill.*

## CAMCO DELUXE PEDAL

**"THE PEDAL OF  
PEERLESS PERFORMANCE"**

The vast number of "Big Names" who are using the Camco Deluxe Pedal is definite proof that it has stood the test of time and fully meets the exacting demands of the Modern Drummer.

Its mechanical perfection plus rugged construction are two of the chief reasons for its popularity.

Simplicity of adjustments eliminates guess-work and permits the Drummer to arrive at the desired feel, balance and flow; and with just the right amount of resistance that suits him best . . . This assures smooth, easy and fast action at all tempos.

Positively frictionless and quiet.

Here is the pedal that does not divert the mind, allowing the Drummer to put more emphasis on stick technique.

**5000 Split Footboard  
\$27.50**

**5000-S One Piece  
Footboard  
\$27.50**

**Ball Bearings**

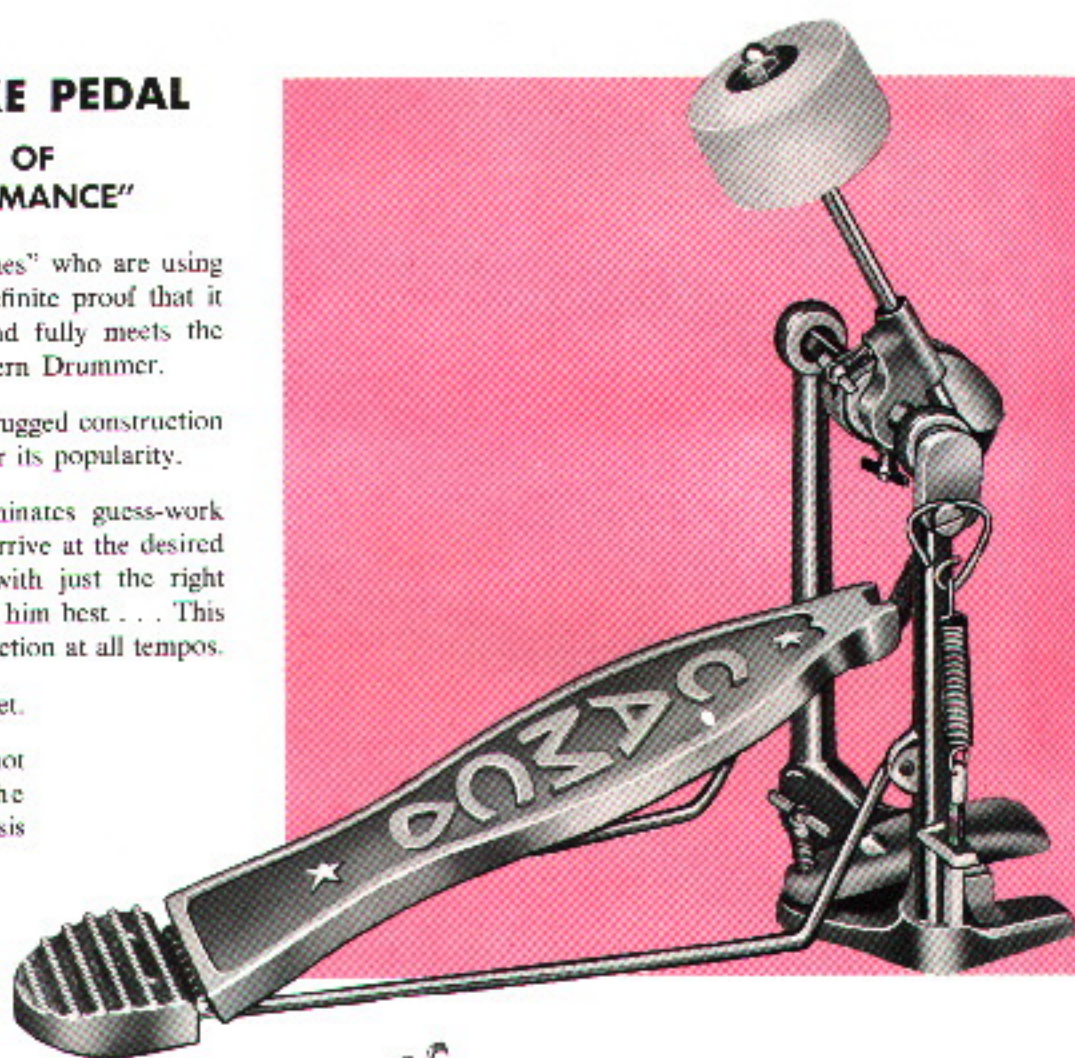
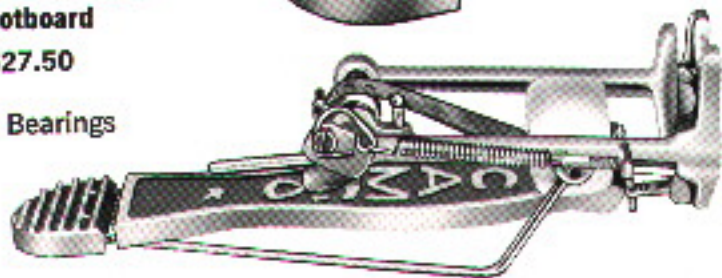

Polished aluminum and chromium-plated parts . . . equipped with solid felt beater ball unless otherwise specified . . . weighs only 3½ lbs. . . . folds easily and compactly without removing any parts whatever.

## CAMCO STANDARD PEDAL

**"Exceptional Efficiency in a Lower-Priced Model"**

Polished aluminum and baked enamel parts . . . equipped with cork beater ball . . . weighs 3½ lbs. . . . folds compactly without removing any parts.

**6000 . . . . . \$21.00**  
**Ball Bearings**

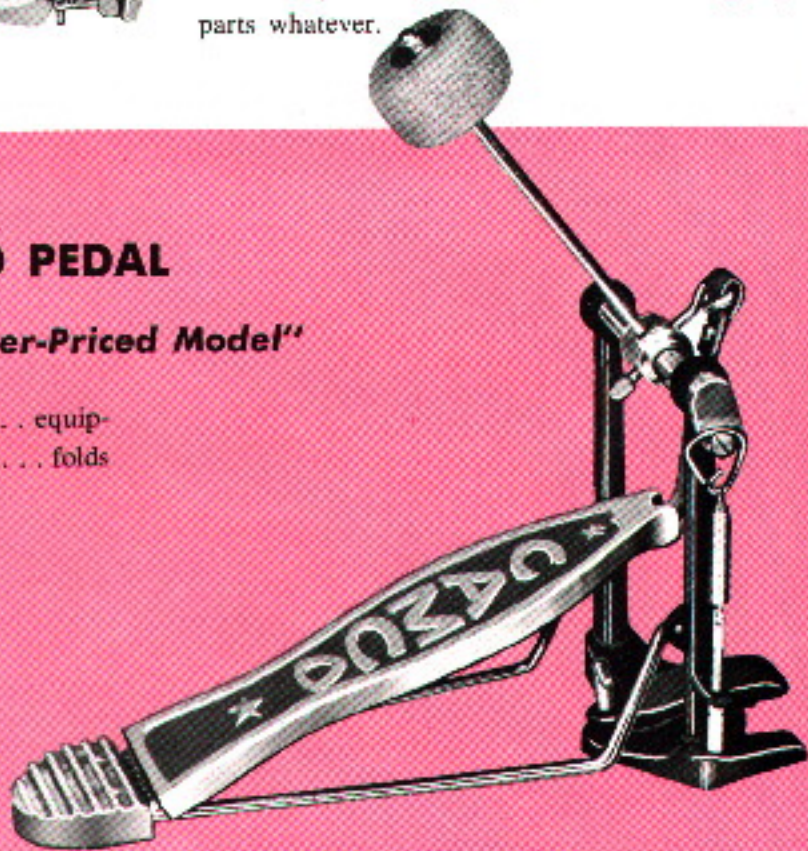

**NEW CAMCO DIRECT PULL HI-HATS**

Newest improved Hi Hat on the market in both tripod and flush base. All features shown by arrows are included in both Hi Hats.

**500 HI-HAT**  
split footboard  
**\$39.50**

**500-S HI-HAT**  
One Piece Footboard  
**\$39.50**

**900 HI-HAT**  
split footboard  
**\$39.50**

**900-S HI-HAT**  
One Piece Footboard  
**\$39.50**

**NEW IMPROVED CLUTCH**

**CYMBAL TILTING ADJUSTMENT**

**KNURL KNOB FOR SPRING ADJUSTMENT THAT CAN BE CHANGED AT WILL**

**LOCK SCREW FOR SPRING ADJUSTMENT KNOB**

**TWO HEAVY SPURS PREVENTS CREEPING**

All Chrome Plated.

**THE FAMOUS "CAMCO" DELUXE HI-HAT**

All of the desired qualities in Hi-Hat mechanism and playing ease are positively to be found in this exceptional model. The drummer can be so sure of "no hugs" that he can devote his full attention to cymbal sounds. Floor flush steel legs. Will not creep. Height adjusting.

**800 Chrome Only \$24.00**

Cymbal not included

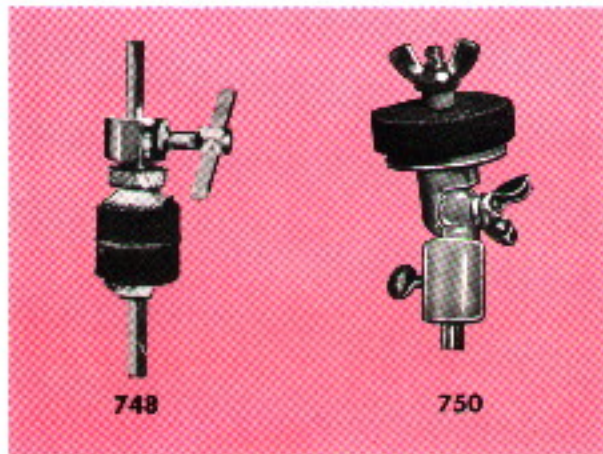

**CAMCO HI-HAT CLUTCH**

Simple and efficient.

**748 ..... \$2.40**

**CAMCO TILTER**

Precision die cast, can't slip ratchet.

**750 Chrome ..... \$2.40**

**751 Nickel ..... \$2.00**

**WALBERG REGULAR HI-HAT**

**502N Nickel ..... \$15.00**

**502C Chrome ..... \$18.00**



**CAMCO DELUXE  
CYMBAL STAND**

Tilter included.  
Modern and very  
practical cymbal  
stand. Light  
weight—Rigid,  
too. Has wide-  
spread folding  
steel legs.  
Extends to 48".

**700 Chrome  
Only — \$14.00**

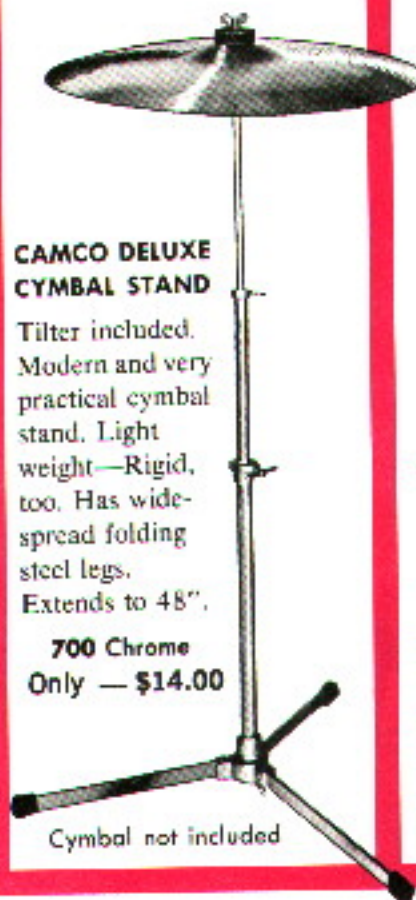

Cymbal not included



**"CAMCO" FLUSH BASE  
DRUM STAND**

Folding legs open flush  
to floor. Ratchet angle  
adjustment. Extendable  
for standing position. A  
high quality stand.

**600 Chrome Only .. \$15.00**

**BUCK ROGERS  
DRUM STAND  
FLUSH BASE**



**850 \$17.50**

**BUCK ROGERS  
DRUM STAND  
TRIPOD BASE**



**650 \$17.50**



**CAMCO THRONE**

Chrome Only. A steel screw  
through steel collar elimin-  
ates all possibilities of slip-  
ping.

Back rest \$2.25 extra.

**9000..... \$21.00**



**WALBERG THRONE**

An old reliable rigid  
model — Padded seat.  
Back rest \$2.25 extra.

**865-N Nickel ... \$17.50**

**NO. 710  
HEAVY EXTRA HIGH  
CYMBAL STAND**

Raises to 58" High  
Has New Swivel Tilter

**\$20.00**

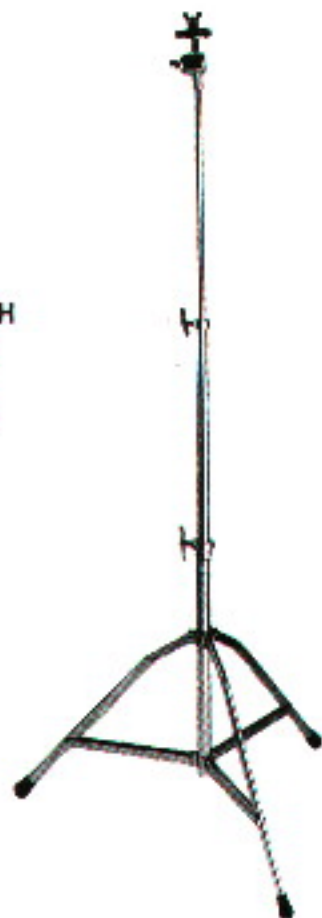

## CYMBAL HOLDERS

## COW BELL HOLDERS



**No. 1450**  
**\$8.50**



Disappearing shell  
mount cymbal  
holder, Chrome.  
**No. 1440 . . . \$5.00**

Tilters  
included



Height adjusting  
telescope cymbal  
sleeve.  
Chrome Only.  
**No. 1445 \$5.00**



**NO. 755**  
**NEW SWIVEL**  
**TILTER**

**\$4.50**

## CAMCO PEDAL PRACTICE PAD

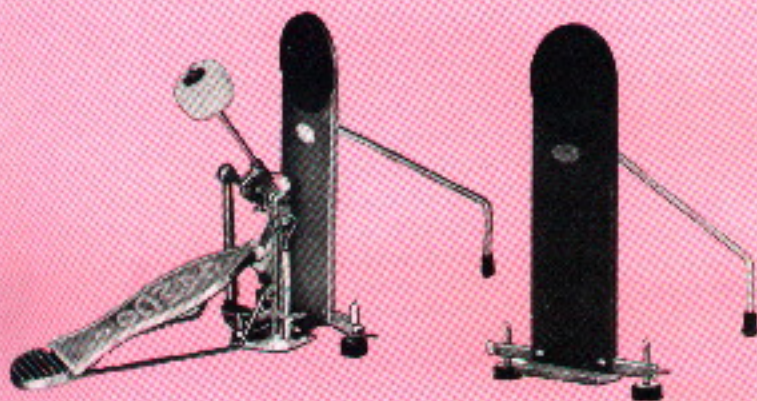

The importance of "foot work" in modern drumming equals that of stick technique. This practical pedal practice pad is the most advanced design made. It is well made of aluminum and steel parts, with a rubber disc beating surface. Takes up very little space. It will definitely improve "the beat."

**1000 . . . . . \$8.50**



## BRUSH CYMBAL HOLDER

A new high post model. Cymbal is placed higher for less reaching and it has the extra strong "Camco" hoop clamp.

**1428- Chromium AAA . . . . . \$2.90**

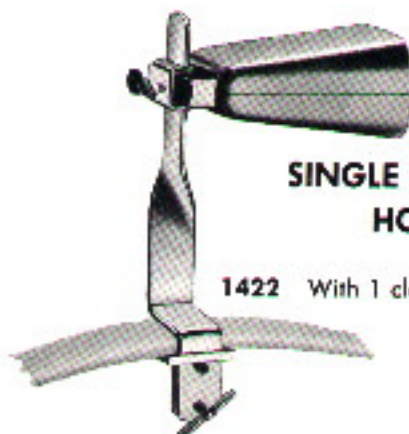

## SINGLE COW BELL HOLDER

**1422 With 1 clamp . . . . . \$3.00**

# TOM-TOM HOLDERS

**CAMCO**

## NEW MODERN SWIVEL TOM - TOM HOLDERS

Made From All Machine Parts  
No Castings to Break  
Chrome Plated

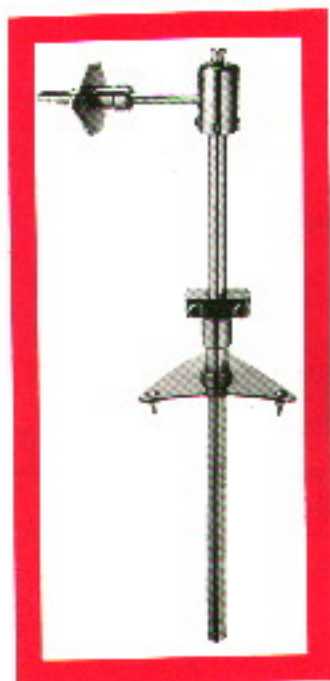

15 Single Swivel Tom-Tom Tolder ..... \$20.00

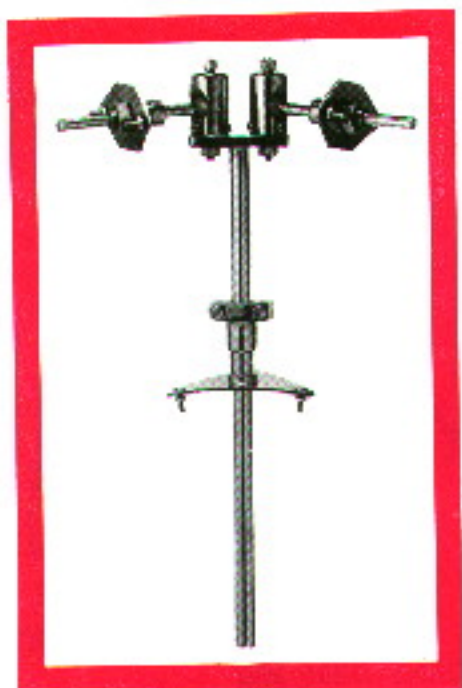

18 Double Swivel Tom-Tom Holder ..... \$27.50

13 Triple Swivel Tom-Tom Holder ..... \$40.00

19 Double Swivel Tom-Tom Holder  
Mounted on Stand ..... \$35.00

## THE CONSOLE TOM-TOM HOLDER



A popular model which has full adjustments. Well made and very strong.

1435-C	Chrome	.....	\$13.50
1435-N	Nickel	.....	\$10.50
1435-CD	Chrome Double Tom-Tom Holder	.....	\$20.00

## DOUBLE TOM-TOM HOLDER



14 Double Tom-Tom Holder..... \$20.00

16 Double Tom-Tom  
Holder on Stand ..... \$24.00

## DISAPPEARING SPURS

Shell Mount, rubber tips included. The square rods are arched and point straight to the floor. They slide in a square notch in the round housing - cannot turn. More floor spread than others. Made of all strong machine parts to stand heavy wear and to last. Can be mounted straight to the floor or can be mounted to tilt forward.

1480 Pair, Chrome ..... \$8.50

## DISAPPEARING SPURS

Shell Mount, round steel rods slide in and out of bass drum shell. Can be used with either rubber or pointed tip.

1705 Pair, Chrome ..... \$5.00

## REGULATION SPURS

Hoop Mount. Equipped with 3 1/2" spikes. Often used as extras for additional assurance against creeping on uneven floors.

1542 Pair, Nickel Only ..... \$1.40

## BASS DRUM ANCHOR

Hoop Mount. Hoop clamp with two reversible spurs. Can use either steel points or rubber tips.

1601 Chrome ..... \$6.00

1602 Nickel ..... \$5.00

## STICK-FAST SPUR ANCHORS

For all Model Spurs. Spurs fit into rubber cone bases. The sponge rubber floor grips will not creep.

1544 Pair ..... \$4.90



1480

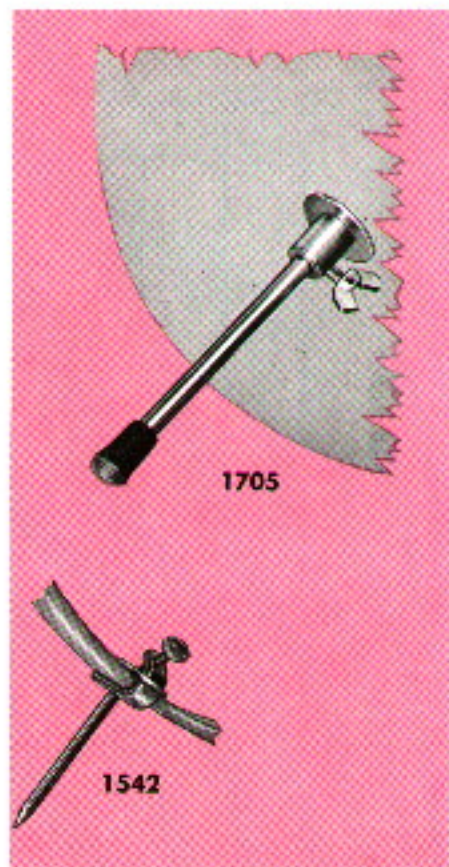

1705

1542



1601

1602



1544

## PEDAL BEATER BALLS AND RODS FOR ALL SOUNDS



**SOLID CORK**  
Solid sound  
All-around work  
250 - \$2.00



**LAMB'S WOOL**  
Soft boom sound  
Concert work  
251 - \$3.00

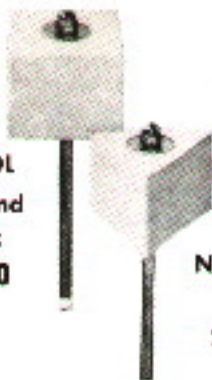

**THUMPER  
SQUARE  
AND  
TRIANGLE**  
New dimension  
in sound  
255 - \$3.50  
each



**SOLID FELT**  
Medium sound  
Most used  
253 - \$3.00



**SOLID WOOD**  
Rock and roll  
and bombs  
254 - \$2.00

# Camco HICKORY DRUM STICKS

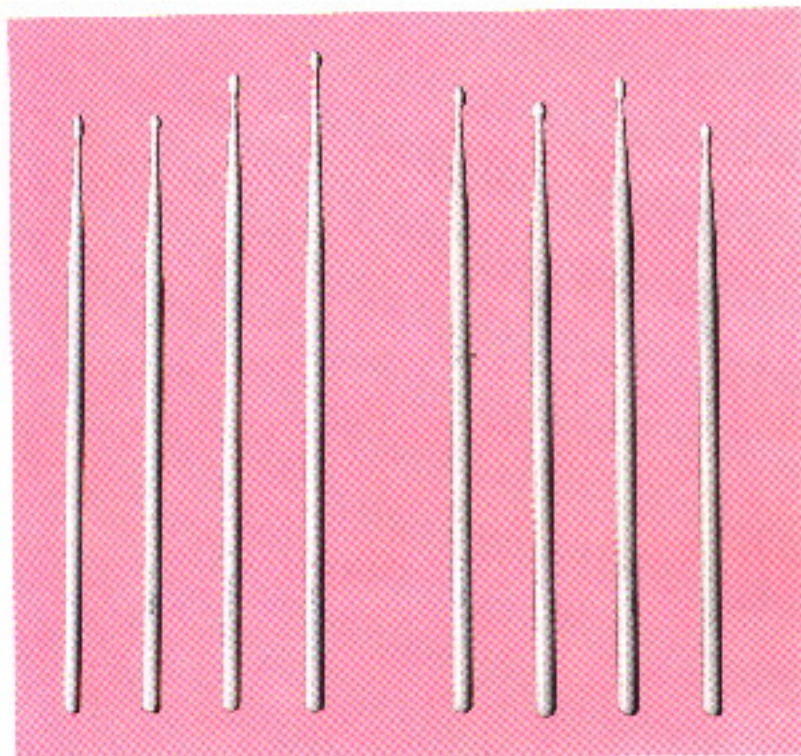

PEE WEE 7-A 0-B 1-A

## JAZZ MODELS

Extra light weight

15" 15½" 16¼" 17"

2-A 3-A 5-A 6-A

## DANCE AND SCHOOL MODELS

Light weight

15¾" 15½" 16" 15"

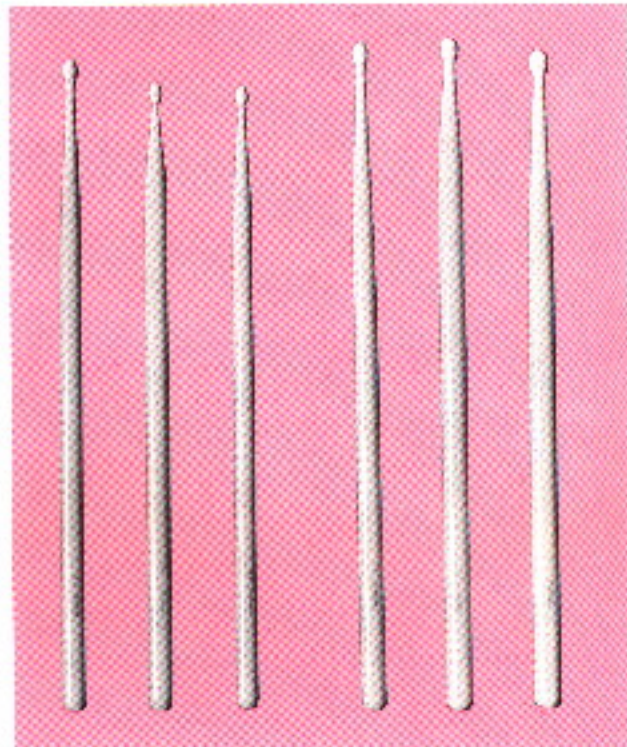

1-B 2-B 5-B

## CONCERT MODELS

Medium weight

16½" 15¾" 16"

1-S 2-S 3-S

## PARADE MODELS

Heavy weight

17" 17" 17½"

We invite drummers to compare our sticks with others. It will readily be noticed that these are "ultra" models. Two new extra operations have been added that have not been heretofore employed. The thoroughly dried hickory is the best obtainable and our workmanship shows in every stick. **\$1.60 pr.**

**NEW . . . ASTRO OAK  
DRUM STICKS  
\$1.60 pr.**



## MODELS

5-A  
7-A  
8-A  
Pee-Wee  
2-B  
5-B  
3-D  
8-D  
1-S  
2-S  
3-S

**NYLON TIP STICKS \$1.95 pr.**



5-A Nylon



7-A Nylon

# Camco PRACTICE PADS

Natural Gum Rubber on all Pads . . . Rubber Non-slip Feet . . . Red Glossy Enamel Finish

The "PROFESSIONAL" 9"x7"  
1210 — \$5.50



The "STANDARD" 8"x7"  
1215 — \$3.00

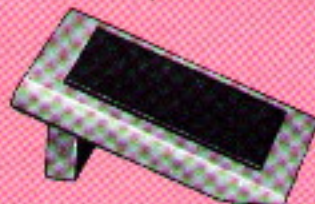

The "HEAVY DUTY" 9"x7"  
1212 — \$5.50

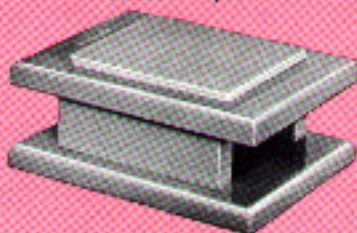

Natural Gum  
The 6" RUBBER DISC  
1230 — \$1.50



## PRACTICE PAD

Has 6" Round Live Rubber Pad in Center. Pro-  
tects Head in Case.

1100-14 for 14" DRUM

PRICE .....\$3.00

## PRACTICE PAD STAND

1160 — Stand Only \$8.50

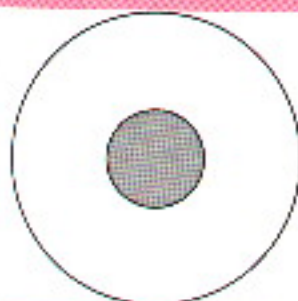

## Camco WIRE BRUSHES "The Choice of Most Professionals"



Rubber Covered Handles  
Loop Ends  
1070  
Pair — \$1.80



Rubber Covered Handles  
Ball Ends  
1072  
Pair — \$1.90



Plain Aluminum Handles  
Loop Ends  
1074  
Pair — \$1.60



Plain Aluminum Handles  
Ball Ends  
1076  
Pair — \$1.80

## CAMCO BASS DRUM STICKS

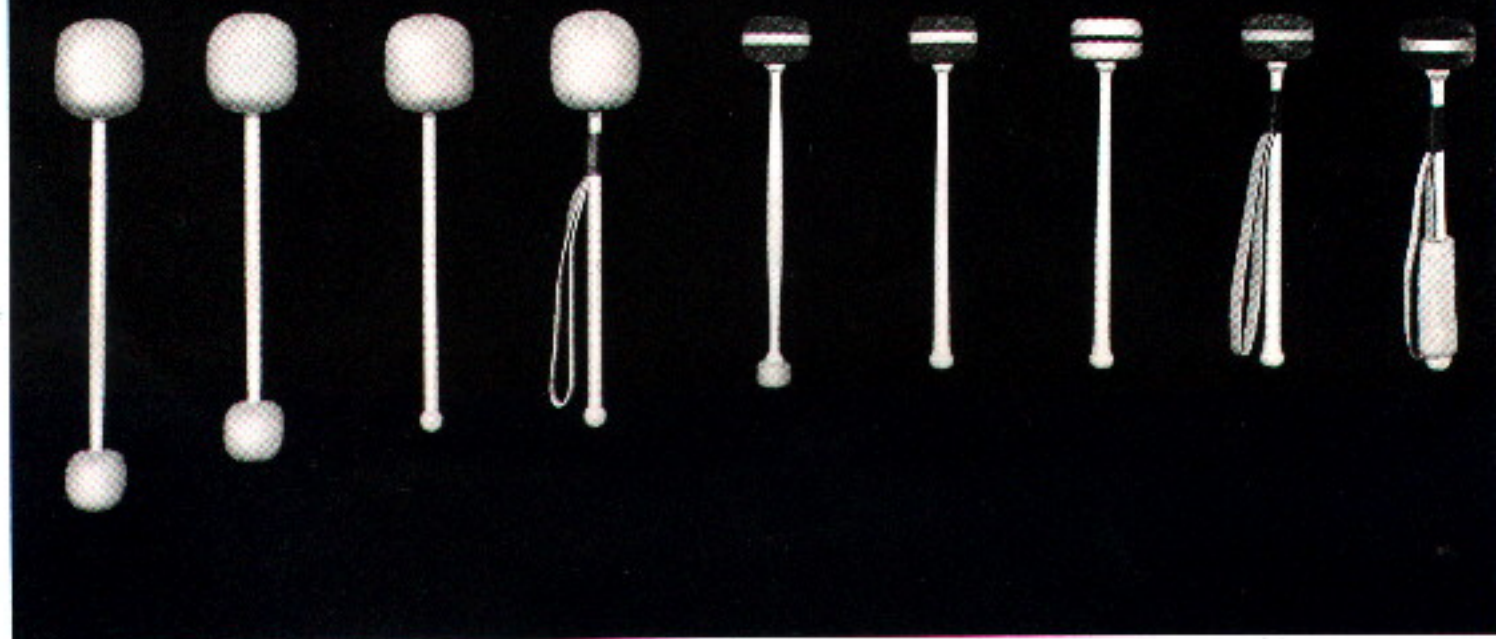

Lamb's Wool  
Double End  
Extra Length  
17½" Overall

1001  
\$5.50

Lamb's Wool  
Double End  
Regular Length  
16" Overall

1002  
\$5.50

Lamb's Wool  
Single End  
Wood Grip  
15" Overall

1003  
\$5.00

Lamb's Wool  
Single End  
With Sling  
15" Overall

1004  
\$6.00

Felt Hi-Grade  
Medium Hard  
Double End  
13½" Overall

1005  
\$4.50

Felt Hi-Grade  
Medium Hard  
Wood Grip  
13" Overall

1006  
\$4.00

Felt Super Grade  
Hard Wood Grip  
13" Overall

1007  
\$4.50

Felt Hi-Grade  
Medium Hard  
With Sling  
13" Overall

1008  
\$6.00

Felt Hi-Grade  
Medium Wool  
Grip With Sling  
13" Overall

1009  
\$8.50

## CAMCO TYMPANI STICKS

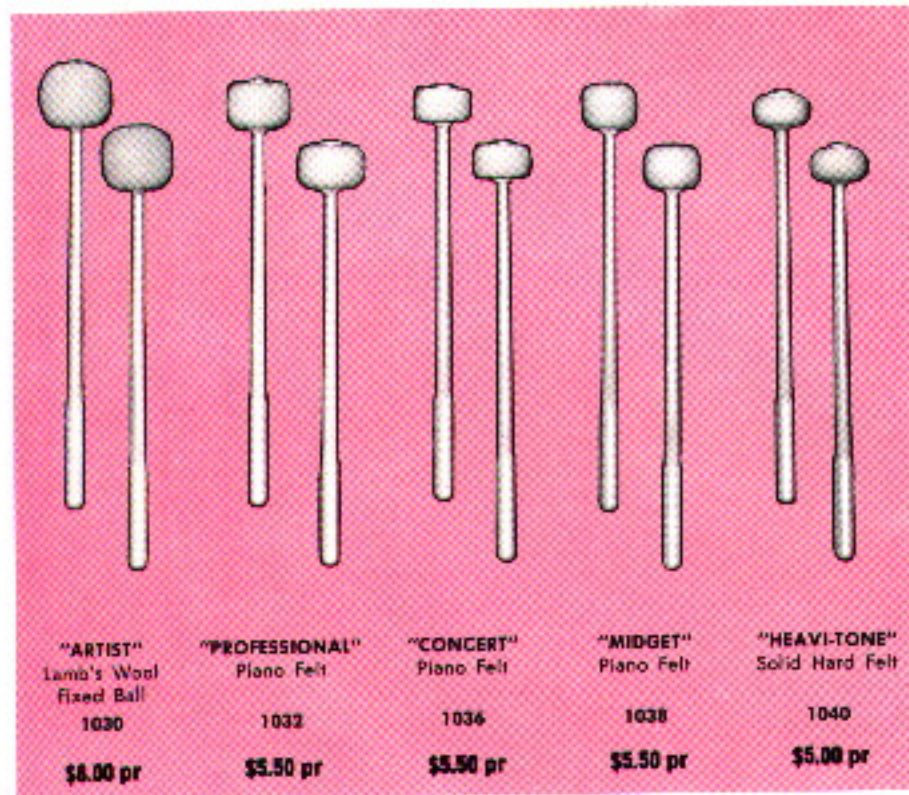

LAMBS  
WOOL

930  
\$6.50  
pr.

METAL HANDLES



PIANO  
FELT  
938  
\$6.00  
pr.



SOLID  
FELT  
940  
\$5.50  
pr.

"ARTIST"  
Lamb's Wool  
Fixed Ball  
1030  
\$8.00 pr

"PROFESSIONAL"  
Piano Felt  
1032  
\$5.50 pr

"CONCERT"  
Piano Felt  
1036  
\$5.50 pr

"MIDGET"  
Piano Felt  
1038  
\$5.50 pr

"HEAVY-TONE"  
Solid Hard Felt  
1040  
\$5.00 pr

## SCOTCH BASS DRUM STICKS

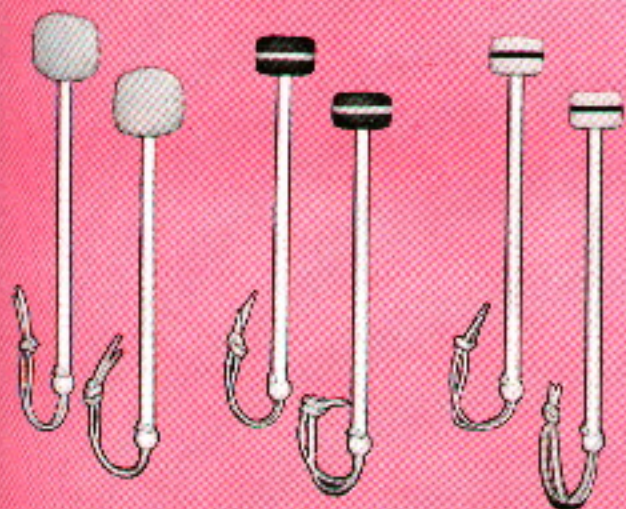

Lamb's Wool  
Soft Leather  
Thongs  
14" Overall  
1012  
\$8.50

Hi-Grade  
Medium Hard Felt  
Leather Thongs  
14" Overall  
1014  
\$5.50

Super Grade  
Medium Hard Felt  
Leather Thongs  
14" Overall  
1016  
\$6.50

## CAMCO TENOR DRUM STICKS

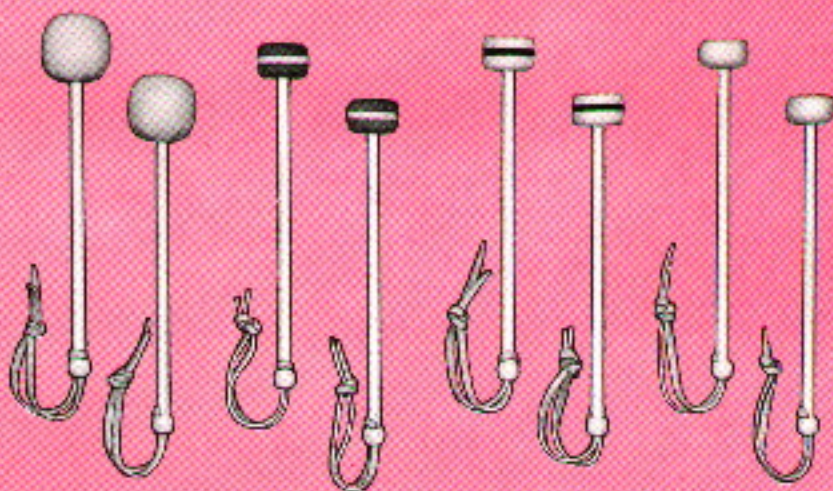

SOFT  
Lamb's Wool  
12" Overall  
1020  
\$8.00

SEMI-HARD  
Hi-Grade Felt  
12" Overall  
1022  
\$5.50

SEMI-HARD  
Super-Grade Felt  
12" Overall  
1023  
\$8.00

SOLID  
Medium Felt  
11 3/4" Overall  
1024  
\$5.50

## SPECIALTY STICKS

### Metal Handle Scotch Bass Drum Sticks



916 ..... \$7.50

### Marshall Thompson All Purpose Sticks Soft Felt



\$3.00 pr.

### Veri-Sonic Sticks



5 Colors  
5 Models  
Dance  
Pencil  
Parade  
Orchestra  
Lt. Orchestra

\$4.50 pr.

### All Purpose Sticks Firm Felt



\$3.00 pr.

### Metal Handle Tenor Drum Sticks



923 ..... \$7.00 pr.



## AVEDIS ZILDJIAN CYMBALS

No other make of cymbal in the world has the wide endorsement of the Avedis Zildjian brand. They have that "something" in blare, brilliance and rich sounds that has never been equalled. That, of course, is the reason the great majority of professional drummers, as well as concert band and symphony orchestra conductors, choose them above all others both in this country and abroad. Avedis Zildjian and his sons—Bob and Armand—personally mix the secret alloy in a closely-guarded laboratory, just as it was formulated in 1623. After casting they are fired, hammered, shaped and tempered many times under high temperatures. All of this (and much more) plus great skill, assures the resonance and strength for which they are world-famous.

Please specify thickness desired.	8"	16.00B
Extra Thin	10"	20.00B
Thin	12"	30.00B
Medium	13"	35.00B
Medium Heavy	14"	40.00B
Heavy	15"	45.00B
	16"	50.00B
	17"	55.00B
	18"	60.00B
	19"	65.00B
	20"	70.00B
	21"	75.00B
	22"	80.00B
	24"	100.00B

We carry a large stock of all sounds . . . If you will describe the usage intended—and size of organization—we will be glad to make careful personal selections.

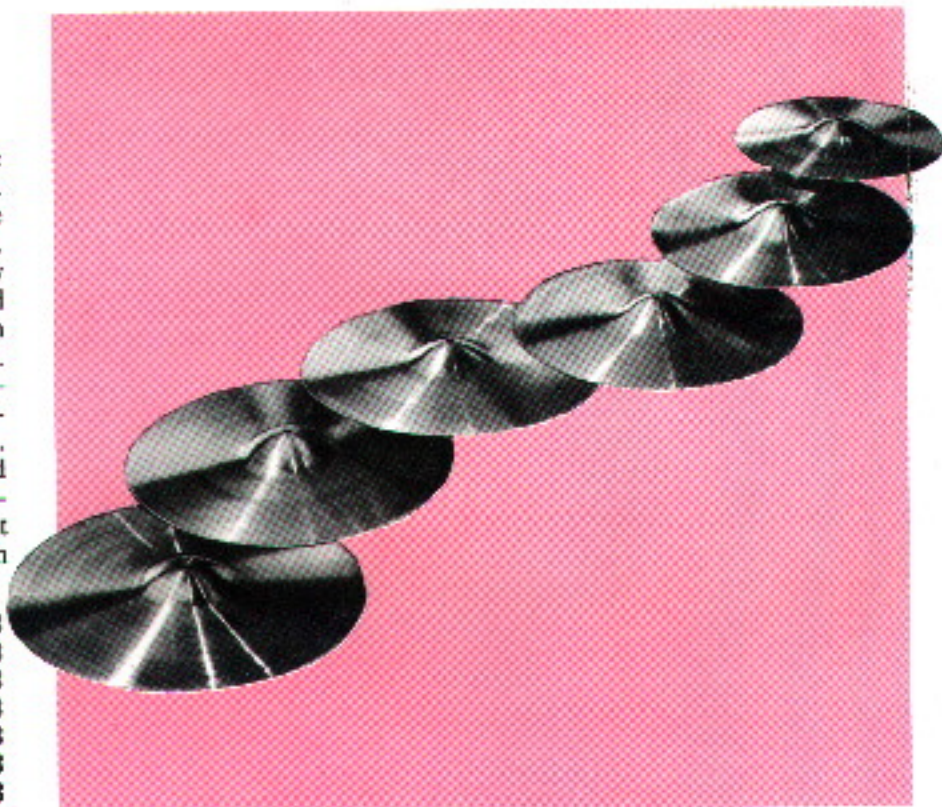

### AVEDIS ZILDJIAN SIZZLE CYMBALS

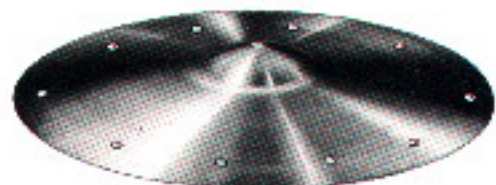

Exactly the same cymbals as the Avedis Zildjian listed above, with sizzle rivets added. Use the same prices for the same size. Please state number of rivets desired.

### GREEKO CYMBALS



Nickel Silver—3½" and 3¼" with hoop clamp.

222 Pair . . . . . \$5.00 pr.

### FINGER CYMBALS



Brass alloy. Highly polished. The tones are brilliant. 2⅛" diameter.

220 Set of 4 . . . . . \$6.00 set

### AVEDIS ZILDJIAN GONGS AND STANDS

Cast of Zildjian Metal. Deep, rich, powerful, realistic gong tones.

20"	\$ 80.00B
22"	90.00B
24"	120.00B
26"	140.00B
28"	180.00B

1592 Gong Stand. Folding Legs.  
Ring Made to Order.  
State Size . . . . . \$30.00

### KRUT CYMBALS - ENGLISH IMPORTS

12"	\$ 8.90 ea
13"	11.40 ea
14"	13.50 ea
15"	16.00 ea
16"	19.80 ea
18"	25.80 ea
20"	33.00 ea
22"	41.40 ea

For Rivets in Cymbal — add \$2.00

## CYMBAL STRAPS AND PADS

These cymbal straps and pads are cut with "a little extra" in length, width, and thickness—a little larger than most models. This gives longer wear and is a great assist in overcoming fatigue and the tempo problem. Made of top grain "pearl elk" leather. Note that we supply knot washers.

### REGULATION

1051	Straps, Pair .....	\$1.80
1052	Pads, Pair .....	2.50

### LAMB'S WOOL COVERED

1054	Straps, Pair .....	\$3.50
1056	Pads, Pair .....	6.00

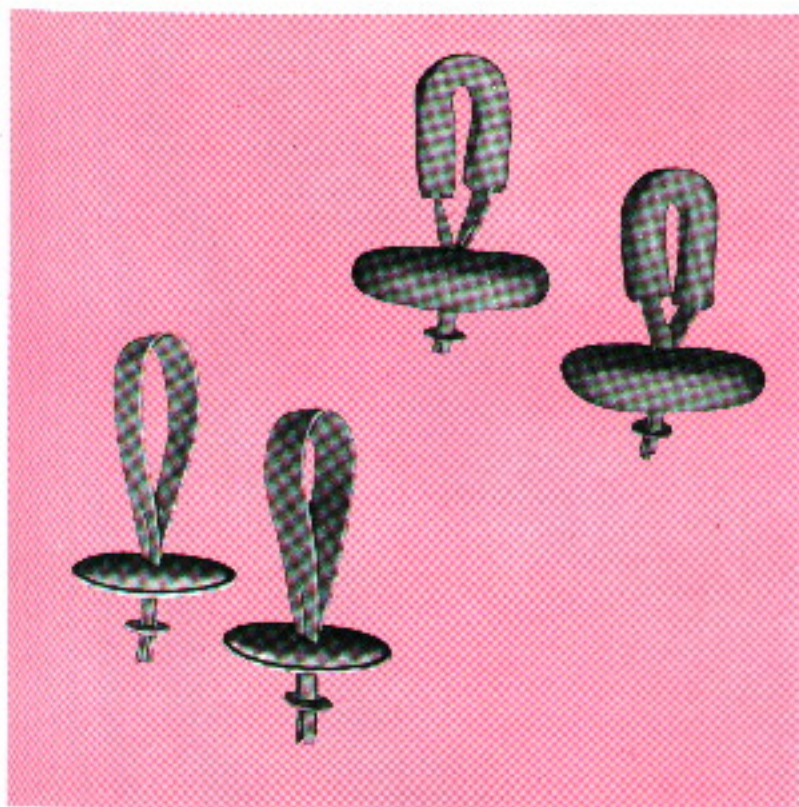

### THE CORRECT WAY TO TIE A CYMBAL KNOT



Lay the four leather ends flat in the cymbal cup

Fold No. 1 to the right and over No. 2

Fold No. 2 downward and over No. 1

Fold No. 3 to the left and over No. 2

Fold No. 4 upward over No. 3 and under No. 1 Pull ends tight.



### BAND CYMBAL HOLDER

Heavy extra strong holder with two "Camco" hoop clamps that prevent slipping.

1427 Chromium AAA ..... \$6.50

### WOOD CYMBAL HANDLES

249 Pair ..... \$2.50



## 'CHING-RING'



**CHING-RING**  
7" STEEL SOUND-RESONATING RING  
8 pr. QUALITY CHINGLES  
ADJUSTABLE STEEL STRAP  
FINE FINISH  
\$11.95

### CAMCO'S NEW ADJUSTABLE THROW OFF CYMBAL SIZZLER

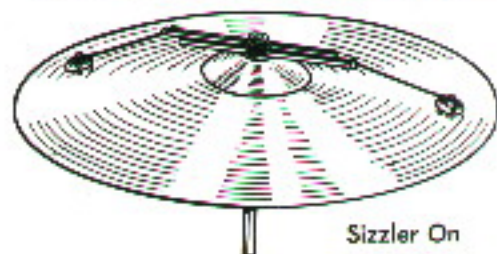

Sizzler On

No. 730  
Price \$3.60

Patent No.  
3,009,379

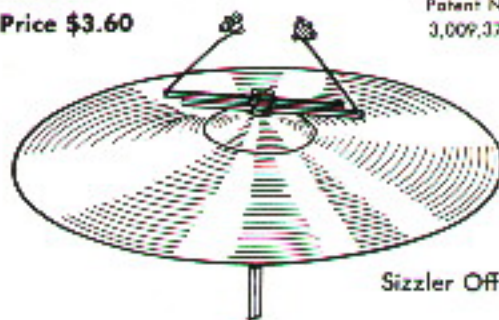

Sizzler Off

## PLASTIC DRUM HEADS

CRISP, EASY PLAYING,  
EVEN TENSION DRUMS  
ASSURED... RAIN OR SHINE

Thousands now in use among leading  
professionals and in the schools.

### CAMCO TOM-TOM OR BATTER SIDE

For 12" Shell.....	\$7.50
For 13" Shell.....	7.50
For 14" Shell.....	7.50
For 15" Shell.....	7.50
For 16" Shell.....	7.50

### CAMCO SNARE SIDE

For 13" Shell.....	\$6.50
For 14" Shell.....	6.50
For 15" Shell.....	6.50
For 16" Shell.....	6.50

### TYMPANI

25".....	\$21.00
28".....	24.00

### WEATHER KING BATTER SIDE OR TOM-TOM

For 13" Shell.....	\$7.00
For 14" Shell.....	7.50
For 15" Shell.....	8.00
For 16" Shell.....	8.50

### WEATHER KING SNARE SIDE

For 13" Shell.....	\$6.00
For 14" Shell.....	6.50
For 15" Shell.....	7.00
For 16" Shell.....	7.50

### CAMCO BASS DRUM

For 18" Shell.....	\$15.00
For 20" Shell.....	\$17.00
For 22" Shell.....	18.00
For 24" Shell.....	19.00
For 26" Shell.....	21.00
For 28" Shell.....	22.00
For 30" Shell.....	23.00
For 32" Shell.....	25.00

Please Order by Size of Drum Shell Only

## REMO VERSATILIC DRUM PRACTICE SET



Model RPS 10 - \$70.00B

## PLASTIC BANJO HEADS

11" ..... \$8.00

## REMO TUNABLE PRACTICE PADS

Tension them like a drum, they feel like a drum, provide a realistic approach to the development of superior all around drum techniques.

Model RT 6".....	\$7.50
Model RT 8".....	\$10.00
Model RT 10".....	\$12.00



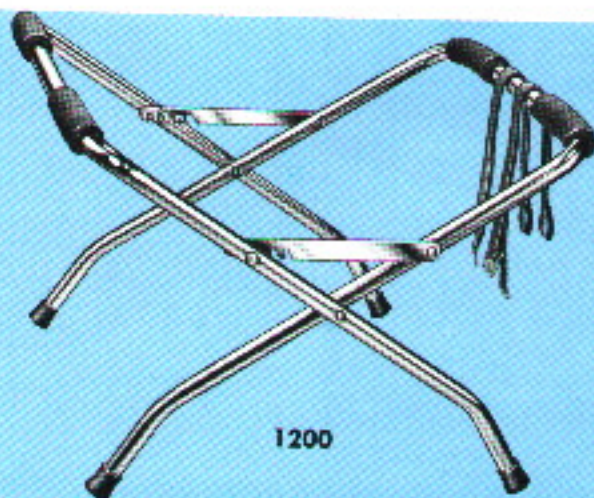

1200

## BASS DRUM RACK

Over 1,000 high school, college and professional bass drummers are now using this—the top prize winner of all bass drum racks. Many have voluntarily stated that it is the strongest and best looking rack they have ever seen. Made of 1" diameter steel tubing instead of the usual 3/4" size. All chrome plated. It also opens wider and will accommodate the largest drums.

1200 Chrome .....\$25.00



1048

## SOLID WOOD BASS DRUM BEATERS

Solid rock maple. Natural lacquer finish. Usually used in pairs for the loud rudimental beats on parade. 12 1/2" Overall.

1048 Each .....\$2.50



23  
26



No. 114



355

## ACME DRUM MAJOR WHISTLES

All Metal—Easy Blow and Very Loud.

23 Small ..... 1.65  
26 Large ..... 2.00

## KEY HOLDER

Mounts in Shell — Always handy.

No. 114 .....\$1.00



4447



4453



1290

## PARADE DRUM EYE FOR SLING SNAP HOOK

Fits under square head rod.

355 Chrome ..... 40¢  
356 Bass Drum Hook .....\$1.00

## WEB DRUM SLINGS

2" stout webbing. Fine Hardware.

4447 White ..... 2.60

### BASS DRUM

4453 White ..... 5.00

### COMBINATION WRENCH and KEY

1290 ..... 1.50

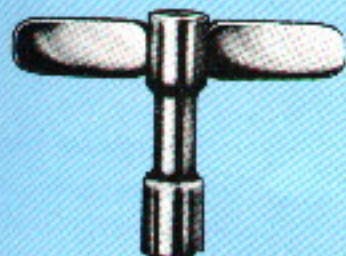

## CAMCO DRUM KEY

1275 ..... 50¢

- Extra Heavy
- Extra Strong

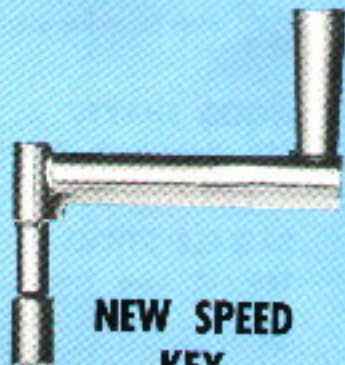

## NEW SPEED KEY

1280 .....\$1.50



## PARADE LEG REST

Self-aligning adjustment. Keeps drum from swaying.

4434 Nickel .....\$4.80  
4437 Chrome ..... 6.75

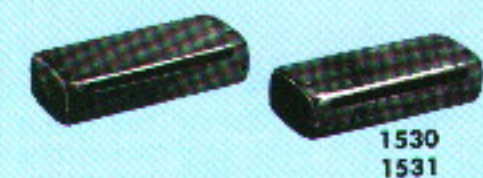

1530  
1531



1104 1103 1102 1101

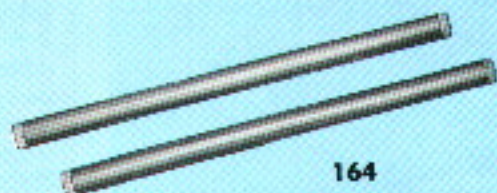

164

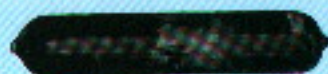

122



117



106



100M



100S



119

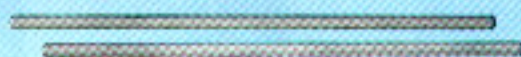

165

### CAMCO WOOD BLOCKS

Made of one-piece rock maple. Rich "clock" (not "click") sound.

1530	6½"	.....	\$3.00
1531	7½"	.....	\$3.50

### MARACA STICKS

Used on tom-toms for a combined maraca effect.

164	Pair	.....	\$3.00
-----	------	-------	--------

### CLAVES

Genuine grenadilla wood, professional size.

106	Pair	.....	\$3.00
-----	------	-------	--------

### COW BELLS

These pressed steel bells are polished and finished in a new Black Finish.

7¼"	5¾"	4¾"	3¾"
1104	1103	1102	1101
\$3.80	\$3.00	\$2.80	\$2.20

### MARACAS

These are genuine Mexican handmade—hand finished. They come in various colors with hand carved floral designs. Available also in a natural wood finish with hand-painted native scenes.

100S	Overall colors and hand-carved floral designs.
Pair	.....
	\$4.00

100M	Overall colors and hand-carved floral designs.
Pair	.....
	\$5.00

### GUIROS

Handmade wood guiros. Highly polished. Lacquer colors.

117	With Scratcher	.....	\$5.40
-----	----------------	-------	--------

### WOOD SHAKER

122	Hand Made, Polished	.....	\$5.40
-----	---------------------	-------	--------

### TIMBALE STICKS

165	15" Long, Pair	.....	60¢
-----	----------------	-------	-----

### METAL-TUBO-SHAKERS

Plenty of volume. Will cut thru large band. Very effective.

119	Large	.....	\$5.00
-----	-------	-------	--------

4732  
4722  
4721  
4720



989



56  
59



27



541 553 556 135 827 824 826



427

1069

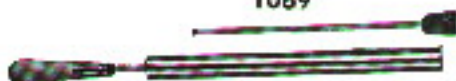

116



560

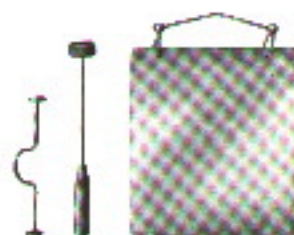

564



568 567 566



505



506



501

### "NO TACK" TAMBOURINE

Solid maple shell. No tacks or staples. Head held by metal band fitting into recessed groove in shell. Easy to replace heads.

989 10" Diameter—12 Pair Jingles.....\$10.75

### REGULAR TAMBOURINES

Maple shells — calf heads. Excellent tambourines. Low priced.

4732 10"—17 Pr. Jingles, Double Row .....\$9.80  
4722 10"—9 Pr. Jingles ..... 8.50  
4721 8"—6 Pr. Jingles ..... 6.00  
4720 7"—5 Pr. Jingles ..... 5.00

### CASTANETS

505 1 Pair on Handles .....\$3.50  
506 2 Pair on Handles ..... 4.50  
501 2 Pair for Fingers ..... 2.50

### BIRD WHISTLES

56 Warbler—Large .....\$3.50  
59 Canary—Small ..... 2.50

### ACME SIREN WHISTLE

27 Made in England .....\$4.50

### SLIDE (SONG) WHISTLE

427 .....\$4.50

### POP GUN

1069 Sure Fire, Loud .....\$9.00

### METAL IMITATIONS

541 Shanghai Rooster .....\$1.50  
553 Hen Cackle ..... 1.50  
556 Baby Cry ..... 1.50  
135 Bob White ..... 1.80  
827 Cuckoo ..... 3.50  
824 3-Tone Train ..... 9.00  
826 2-Tone Train ..... 7.50

### SLAP STICK

116 Rock Maple .....\$4.50

### WOOD RATTLE

Clamps to bass drum hoop. Rock maple ratchet in a metal frame. Very loud and durable.

560 .....\$6.80

### SLEIGH BELLS

568 25 Bells .....\$11.00  
567 13 Bells ..... 7.00  
566 12 Bells ..... 5.00

### STEEL BELL PLATE

564 7"x9"x1/8"—Mallet included .....\$6.00



### TRIANGLE HOLDER

You can be sure that this extra strong holder will remain in place. Gut suspension cord.

1429-Chromium AAA ..... \$3.00

### TRIANGLES

Fine grade steel. Brilliant tones. Heavily plated. Striker included.

810	10"	\$3.15	807	7"	\$1.85
809	9"	2.60	806	6"	1.60
808	8"	2.10	805	5"	1.40

### ONE COW BELL HOLDER

429-N Nickel ..... \$1.50

### TWO COW BELL HOLDER

430-N Nickel ..... \$2.50

### WOOD BLOCK HOLDER

1541-N Nickel ..... \$1.20

### WOOD BLOCK AND COW BELL HOLDER

443-N Nickel ..... \$2.00

### INTERNAL SNARE DRUM MUFFLER

Only Vertical Control on Market. Very Fast.

1115 ..... \$3.00

### CAMCO BASS DRUM MUFFLER

This new idea bass drum muffler has risen to a top favorite in six months time. No springs to deteriorate or rust. The pressure adjustment is directly in center of felt disc. Any color pearl to match your drums. Your choice of Pearls. Please state pearl desired.

1426P All Metal parts chrome plated ..... \$6.00

1426C Chrome Disc ..... 6.00

1430 3" x 25" Bass Felt Muffler ..... \$1.00

## "SNAPPI" COILED WIRE SNARES

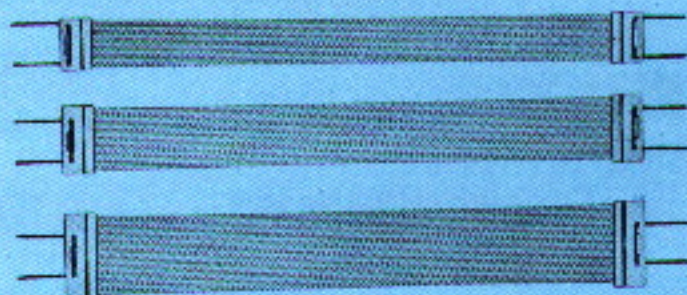

1240	12 Strand for 13" Drums	\$3.30
1241	12 Strand for 14" Drums	3.30
1242	12 Strand for 15" Drums	3.30
1245	16 Strand for 14" Drums	3.60
1247	16 Strand for 15" Drums	3.60
1250	20 Strand for 14" Drums	3.80
1251	20 Strand for 15" Drums	3.80
1252	16 Strand for Super	5.00

# Camco MALLETS



- |   |   |   |   |   |   |   |  |  |
|---|---|---|---|---|---|---|--|--|
| <b>C-1</b><br>1" Soft<br>Yellow<br>Rubber<br>\$1.20 | <b>C-2</b><br>1" Medium<br>Red Rubber<br>\$2.20 | <b>C-3</b><br>1 1/2"<br>Hard Blue<br>Rubber<br>\$2.20 | <b>C-4</b><br>1 1/4"<br>Hard Gray<br>Rubber<br>\$2.20 | <b>C-5</b><br>1" Hard<br>White<br>Plastic<br>\$2.50 | <b>692</b><br>3/4" Solid<br>Brass Balls<br>\$1.50 | <b>C-6</b><br>1 1/2" Hard<br>Red Yarn<br>\$4.50 | <b>C-7</b><br>1 1/2" 1/2"<br>Hard Blue<br>Yarn<br>\$4.50 | <b>C-8</b><br>1 1/2" Med.<br>Soft Yellow<br>Yarn<br>\$4.50 |
|---|---|---|---|---|---|---|--|--|

- C-1** Ideal for practice and 4 mallet playing
- C-2** Excellent for ensemble and solo
- C-3** For greater volume
- C-4** For Xylophone and bells
- C-5** For Xylophone and bells
- 692** For Bells metallic effect
- C-6** For Vibe and Marimba - 2, 3, and 4 mallets
- C-7** Special for Vibe - 2, 3, and 4 mallets
- C-8** For Marimba - 2, 3, and 4 mallets

## BELL-LYRA MALLETS



New balance assures accurate aim—positively guaranteed unbreakable balls. The strongest mallets ever made. You can be sure that the balls will not break. Shafts are of 1/8" special alloy carbon magnesium steel made to our order. The hand grips are semi-hard ribbed rubber. These exclusive features provide a new feel and balance that means better control and therefore better playing technique. One of the most outstanding inventions ever presented in the percussion dept. They are slightly higher in cost because of better materials and workmanship, but they will outlast dozens of the old style models, therefore are much cheaper in the long run.

1050 Pair ..... \$3.80

## INSTRUCTION BOOKS

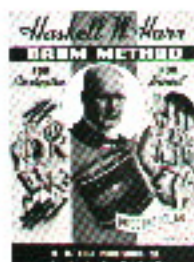

**DRUM METHOD No. 1**

\$2.50B

**DRUM METHOD No. 2**

\$2.50B



**HERTA'S PARADE**

by Sheldon Elias

\$3.00

Vol. 1 ..... \$2.00

Vol. 2 ..... 2.00

Vol. 3 ..... 2.00

Vol. 4 ..... 2.00

A percussion ensemble for high school musicians. Player I marimba, player II snare drum and triangle, player III bass drum and suspended cymbal. An ideal piece for featuring the percussion section in a concert.

## LEATHER BELL-LYRA SLINGS

Fine top-grain sole leather.



- |         |   |                  |         |
|---------|---|------------------|---------|
| Single, | { | 4855 White ..... | \$10.00 |
|         |   | 4853 Tan .....   | 10.00   |
| Double, | { | 4857 White ..... | 15.00   |
|         |   | 4856 Tan .....   | 15.00   |



## ZIPPER DRUM COVERS

All sizes are shell measurements only — allowance is made for hoops. Please state type and size when ordering.

### SNARE DRUM

	Mack- intosh	Dura- lyte		Mack- intosh	Dura- lyte
4x13	\$7.80		5½x14	\$7.80	\$9.20
4½x14	7.80		6½x14	7.80	8.20
5x14	7.80	8.20	8x15	7.80	10.05

### PARADE DRUM

	Mack- intosh	Dura- lyte		Mack- intosh	Dura- lyte
10x14	\$8.40	\$10.50	12x15	\$8.00	\$10.05
10x15	8.70	10.50	12x15	9.00	10.05

### TOM-TOM

	Mack- intosh	Dura- lyte		Mack- intosh	Dura- lyte
8x12	\$8.10	\$8.20	14x14	\$9.00	\$10.50
9x13	8.10	9.20	16x16	8.00	11.10

### BASS DRUM

	Mack- intosh	Dura- lyte		Mack- intosh	Dura- lyte
14x18	\$13.00	\$15.10	10x28	\$16.00	\$18.90
14x20	13.50	15.10	14x24	14.25	18.90
14x22	13.50	15.10	14x28	15.90	18.90

### DURALYTE CYMBAL BAGS

13" and 14"	\$12.30	15" and 16"	\$12.80
18"	13.80	20"	15.00
22"	15.80	24"	17.60

## FIBRE CASES

### SUPER CARRY-ALL CASE

No. 21 Extra Large. Will hold 22" Cymbal has tray and partition	\$46.90 B
No. 21-W Same but with wireels	55.60 B

### REGULATION CARRY-ALL CASE

No. 20 Has tray and partition Will hold 15" Cymbal and extras	\$34.00 B
---	-----------

### STUDENT CASE

Deluxe Case - Blue	\$21.00
--------------------	---------

### TRAY FRAME CASE

No. 40 Metal edge frame will hold 16" Cymbal	\$35.00
--	---------

### PLAIN FIBRE CASE

No. 30 Plain edge frame will hold 16" Cymbal	\$28.00 B
--	-----------

### TELESCOPE SNARE DRUM

Will take drums up to 8" shell depth 14" dia. shell	\$16.80 B	15" Dia. shell	\$17.00 B
---	-----------	----------------	-----------

### PARADE DRUM

10x14	\$19.80 B	12x16	\$22.80 B
12x15	22.00 B		

### TOM-TOM

8x12	\$17.50 B	14x14	\$22.00 B
9x13	18.00 B	16x16	23.60 B

### BASS DRUM

14x18	\$31.00 B	14x26	\$42.35 B
14x20	40.00 B	14x28	\$43.45 B
14x22	40.40 B	10x28	\$42.35 B
14x24	41.25 B		

SQUARE SNARE 14"	\$14.50 B
------------------	-----------



No. 21

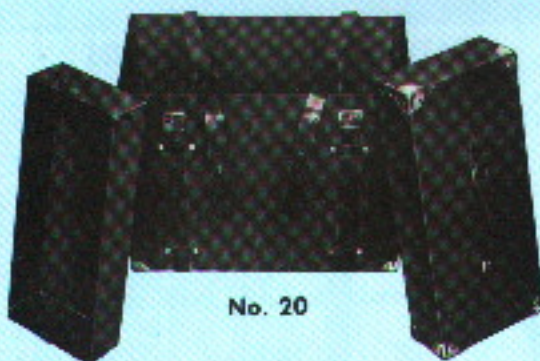

No. 20



No. 40



No. 30



TELESCOPE FIBRE CASES



SQUARE SNARE

# REPLACEMENT PARTS LIST

## STRAINERS

830	Aristocrat Strainer	\$9.50
845	Economy Strainer	4.50
841	Snare Jaw	1.00

## TENSION CASINGS

846	Aristocrat Snare Casings	\$1.40
847	Aristocrat Bass Casings	1.60
848	Tuxedo Snare Casings	1.40
849	Tuxedo Bass Casings	1.60
851	Collar Screw Hoop for Single Flange Hoop	.40
852	Claw Hook for Bass Drums	1.00
853	Claw Hook for Parade Drum	1.00
856	Casing for Cymbal Holder or Tom Tam Legs	1.60
854	Tympani Handle Rods (State Size)	.90

## HI-HAT PARTS

800-202	Leather Strap	\$ .45
800-1	Spring	.30
800-2	Round Felt Washer	.16
800-3	Round Steel Washer	.20
800-4	Round Washer and Bushing	.30
800-5	Base Casting	2.00
800-6	Large Wing Screw for Base	.60
800-7	Strap Screw	.20
800-8	Hex Leg for Heel	.10
800-9	Crutch Tip for Leg on Heel	.10
800-10	Rubber Bumper and Screw for Heel	.10
800-11	Footboard Connection	1.00
800-12	Metal Hinge	.60
800-14	1/4-20 Wing Screw Wide Spread	.34
800-15	1/4-20 Wing Screw	.25
800-16	5/16-24 Wing Screw	.34
800-17	Clamp for Top Tube	.50

## CRUTCH TIPS AND MISCELLANEOUS PARTS

1200-1	1" I.D. Tip for Bass Drum Rack	\$ .30
800-13	Crutch Tip for 800-600-700 Stands	.10
9000-2	3/8" I.D. for Throne and Spurs	.10
9000-1	Locking Ring and Screw for Throne	.80
600-6	Large Knurl Nut for 600 Drum Stand	.40

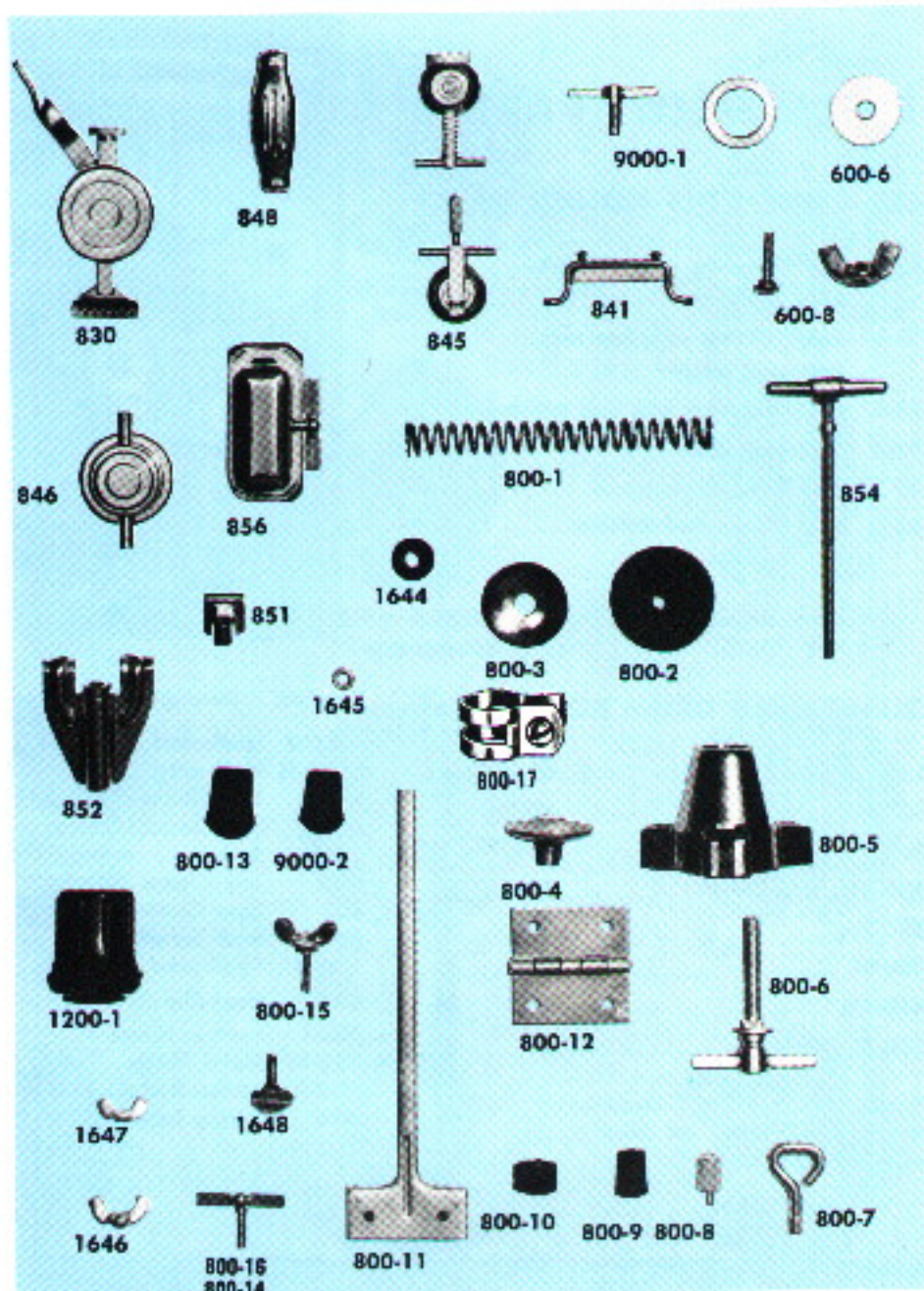

600-8	Bolt and Large Wing Nut	.25
1646	1/4-20 Wing Nut	.10
1647	10-24 Wing Nut	.08
1648	1/4-20 Thumb Screw	.12
1643	Rubber Cymbal Tube	.06
1644	Leather Washer	.10
1645	Tension Rod Washer	.06
1649	10-24 Thumb Screw	.10

## COUNTER HOOPS

Chrome Triple Flange, Snare Side	\$9.50
Chrome Triple Flange, Batter Side	9.00
Wood Bass, Maple	6.00
Wood Bass, Lacquer	6.50
Wood Bass, Pearl Inlaid	7.50
Parade Hoop, Maple	3.00
Parade Hoop, Lacquer	3.50
Parade Hoop, Pearl Inlaid	4.50

# REPLACEMENT PARTS

## 1435 - TOM TOM HOLDER PARTS

- 1435-1 Rail Complete with washers, bolts and nuts.....\$6.00
- 1435-2 Small Clamp complete nut, bolt, and washer ..... 1.00
- 1435-3 Diamond plate with nuts and bolts 3.50
- 1435-4 Extension Rod ..... 1.00
- 1435-5 Hex Key ..... 1.00
- 1435-6 Rail Clamp and Ratchet..... 5.00

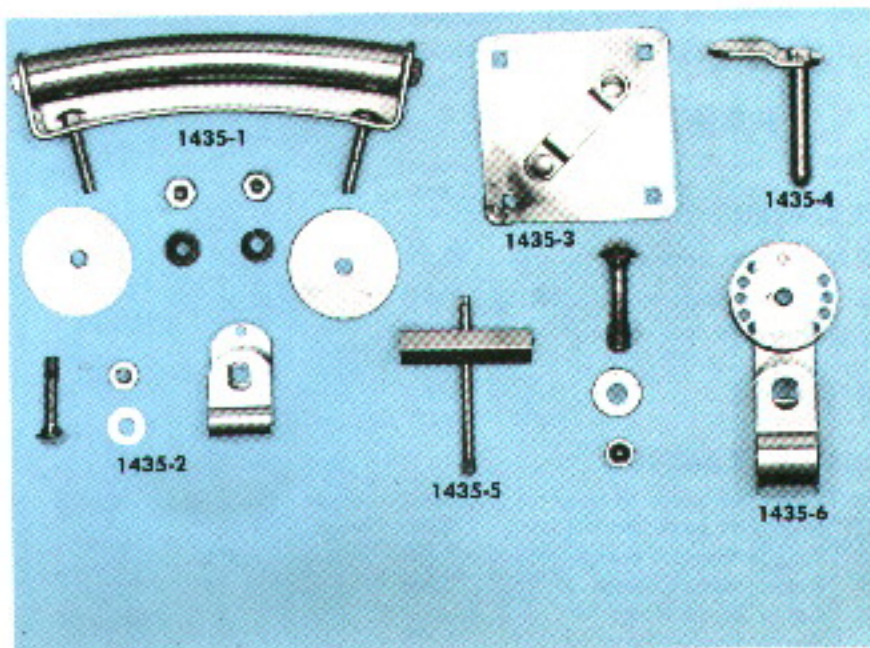

## SQUARE HEAD DRUM RODS

- 4150-1½" ..... \$ .40
- 4187-1¾" ..... .40
- 4250-2½" ..... .40
- 4300-3" ..... .40
- 4350-3½" ..... .50
- 4400-4" ..... .50
- 4450-4½" ..... .50
- 4500-5" ..... .50



Chrome plated. All rod measurements are taken from under the collar to the end of the threads.

Part No.	Description	List Price	Part No.	Description	List Price
5000-F	Footboard only	\$4.00	403	Spring	\$ .22
5000-H	Heel only	1.25	402	Spring Screw	.15
604	Toe Clamp Pin	.06	401	Rocker	.30
603	Toe Clamp Locking Screw	.40	400-A	Rocker and Spring Assembly	.82
602	Toe Clamp Casting	.85	307	Cam Side Bearing Nut	.05
601	Base Casting	6.00	305	Rocker Hub	.20
507-2	Heel Screws	.06	302-2	Bearing	.60
506-2	Footboard Screws	.06	300-A	Hex Shaft Assembly	2.75
504	Heel Clip	.15	203-2	Cam Strap Screws	.05
502-L	Leather Hinge	.30	202	Cam Strap	.45
502-M	Metal Hinge	.60	201	Cam Casting	1.25
500-A	Radius Rod Assembly	1.75	103	Hex Shaft Set Screw	.35
404	Spring Lock Nut	.20	102	Beater Shaft Set Screw	.35
			101	Beater Hub Casting	1.25
			5000-C	Complete Footboard	7.50
			202-N	Nylon Strap	.75

## Camco Pedal Parts

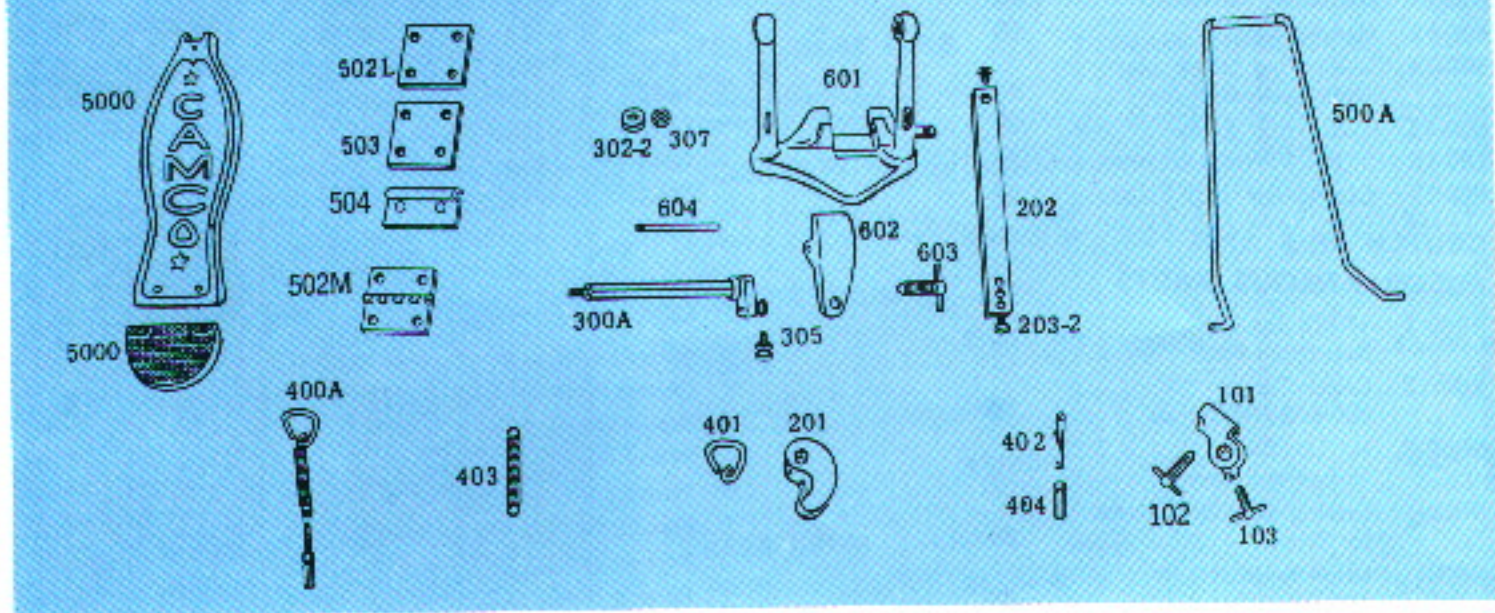



JOEY CASS  
New York



JOE DUKES  
Jack McDuff



RICK FRIGO  
Chicago



NORM JEFFRIES  
Hollywood Palace



STEVE RILLERA  
Santa Ana



SID BULKINS  
Las Vegas



MEL BROWN  
Temptations



EDDIE KNIGHT  
South Bend



HAP GORMLEY  
New York



NORBY KING  
Chicago



KALIL MADI  
Big Tiny Little



TONY CASELLI  
Chicago



PAUL HUMPHREY  
Hollywood



ALAN LASCHIVER  
California



MARSHALL THOMPSON  
Chicago



TONY DEE  
"NTH" Hollywood



DENNIS WILSON  
Beach Boys



JIMMY SMITH  
Erroll Garner



JERRY PUTNAM  
Puerto Rico



MORGAN GRANT  
Honolulu



FRANK KIM  
Honolulu



ROSS HAYASHIDA  
International Set



EDDIE SWAN  
Los Angeles



BART TUNICK  
Seattle



RED SPARKLE



BLUE SPARKLE



SILVER SPARKLE



GOLD SPARKLE



GREEN SPARKLE



OYSTER PEARL



BURGUNDY SPARKLE



CHAMPAGNE SPARKLE



BLACK DIAMOND PEARL

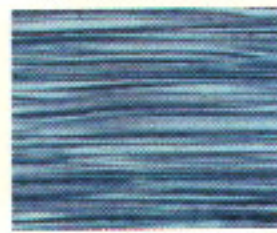

BLUE RIPPLE

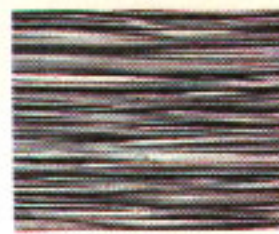

BLACK RIPPLE



WHITE PEARL



CHARCOAL MOIRE



BLUE MOIRE



PURPLE MOIRE



GOLD MOIRE

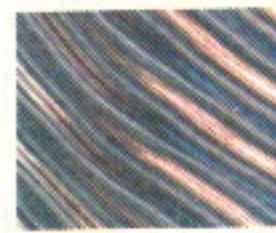

AQUA MOIRE



RED MOIRE

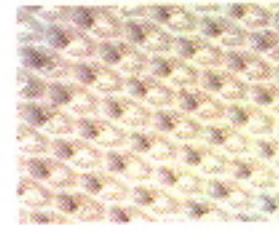

3-D



RED STAIN



EBONY STAIN



CLEAR MAPLE



WALNUT STAIN



MOSS GREEN STAIN

**Camco**

**DRUM COMPANY •**

9221 SOUTH KILPATRICK AVENUE

OAKLAWN ILL 60453 • Area Code (312) PHONE 423-2900